

**Pignons ~ Roues Fonte  
Disques Acier**

**Engrenages à Denture Droite  
Crémaillères**

**Pignons à Moyeu Amovible  
et Moyeux Amovibles**



# *SOMMAIRE*

<b>Pignons 06B</b>	<b>Page 3</b>
<b>Pignons 081</b>	<b>Page 4</b>
<b>Pignons 08B</b>	<b>Page 5</b>
<b>Pignons 10B</b>	<b>Page 6</b>
<b>Pignons 12B</b>	<b>Page 7</b>
<b>Pignons 16B</b>	<b>Page 8</b>
<b>Pignons 20B</b>	<b>Page 9</b>
<b>Pignons 24B</b>	<b>Page 10</b>
<b>Pignons 28B</b>	<b>Page 11</b>
<b>Pignons 32B</b>	<b>Page 12</b>
<b>Disques 06B</b>	<b>Page 14</b>
<b>Disques 08B</b>	<b>Page 15</b>
<b>Disques 10B</b>	<b>Page 16</b>
<b>Disques 12B</b>	<b>Page 17</b>
<b>Disques 16B</b>	<b>Page 18</b>
<b>Disques 20B</b>	<b>Page 19</b>
<b>Disques 24B</b>	<b>Page 20</b>
<b>Disques 28B</b>	<b>Page 21</b>
<b>Disques 32B</b>	<b>Page 22</b>
<b>Engrenages à Denture Droite ~ Module 1 &amp; 1,5 - Module 2 &amp; 2,5 (12 à 49 Dents)</b>	<b>Page 24</b>
<b>Engrenages à Denture Droite ~ Module 1 &amp; 1,5 - Module 2 &amp; 2,5 (50 à 127 Dents)</b>	<b>Page 25</b>
<b>Engrenages à Denture Droite ~ Module 3- 4 - 5 &amp; 6 (12 à 127 Dents)</b>	<b>Page 26</b>
<b>Crémaillères Acier C 43 Section Carré ~ Méplat ~ Haute</b>	<b>Page 27</b>
<b>Pignons 06B et 08B à Moyeu Amovible</b>	<b>Page 30</b>
<b>Pignons 10B et 12B à Moyeu Amovible</b>	<b>Page 31</b>
<b>Pignons 16B et 20B à Moyeu Amovible</b>	<b>Page 32</b>
<b>Pignons 24B à Moyeu Amovible</b>	<b>Page 33</b>
<b>Figures des Pignons à Moyeu Amovible</b>	<b>Page 34</b>
<b>Moyeux Amovibles Métriques et Pouces</b>	<b>Page 35</b>

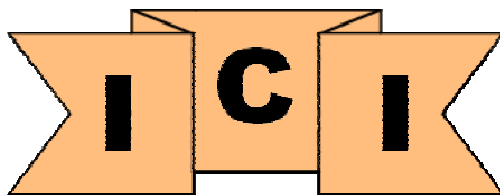

# 06B

Pignon avec moyeu déporté pour  
Chaîne Simple, Double et Triple.  
3/8" ~ 9,525 x 5,72 mm

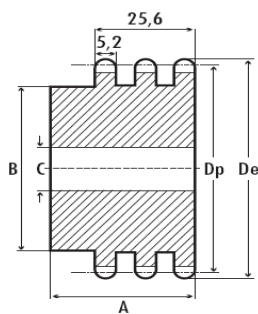
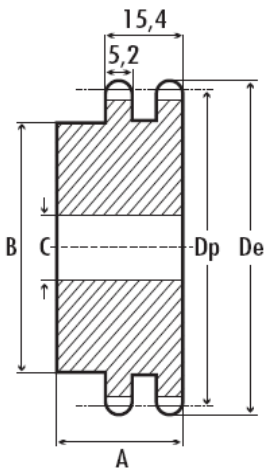
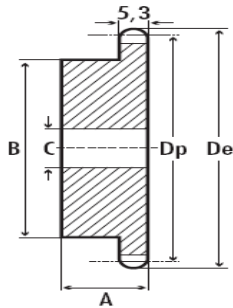

ACIER C43

Pignon Simple

Pignon Double

Pignon Triple

REF(1)	Z	De	Dp	A	B	C	M*	A	B	C	M*	A	B	C	M*
PIG06B008	8	28,0	24,89	22	15	8	0,03	22	15	8	0,04	32	15	8	0,05
PIG06B009	9	31,0	27,85	22	18	8	0,04	22	18	8	0,05	32	18	8	0,07
PIG06B010	10	34,0	30,82	22	20	8	0,03	22	20	8	0,06	32	20	10	0,10
PIG06B011	11	37,0	33,80	25	22	8	0,06	25	22	10	0,08	35	22	12	0,14
PIG06B012	12	40,0	36,80	25	25	8	0,11	25	25	10	0,12	35	25	12	0,18
PIG06B013	13	43,0	39,80	25	28	10	0,13	25	28	10	0,14	35	28	12	0,22
PIG06B014	14	46,3	42,80	25	31	10	0,17	25	31	10	0,16	35	31	12	0,27
PIG06B015	15	49,3	45,81	25	34	10	0,20	25	34	10	0,18	35	34	12	0,32
PIG06B016	16	52,3	48,82	28	37	10	0,27	30	37	12	0,22	35	37	12	0,37
PIG06B017	17	55,3	51,83	28	40	10	0,31	30	40	12	0,28	35	40	12	0,41
PIG06B018	18	58,3	54,85	28	43	10	0,34	30	43	12	0,33	35	43	12	0,45
PIG06B019	19	61,3	57,87	28	45	10	0,40	30	46	12	0,37	35	46	12	0,52
PIG06B020	20	64,3	60,89	28	46	10	0,41	30	49	12	0,43	35	49	12	0,58
PIG06B021	21	68,0	63,91	28	48	12	0,47	30	52	16	0,49	40	52	16	0,69
PIG06B022	22	71,0	66,93	28	50	12	0,48	30	55	16	0,55	40	55	16	0,78
PIG06B023	23	73,5	69,95	28	52	12	0,54	30	58	16	0,66	40	58	16	0,85
PIG06B024	24	77,0	72,97	28	54	12	0,56	30	61	16	0,74	40	61	16	0,95
PIG06B025	25	80,0	76,00	28	57	12	0,67	30	64	16	0,81	40	64	16	1,05
PIG06B026	26	83,0	79,02	28	60	12	0,68	30	67	16	0,88	40	67	16	1,15
PIG06B027	27	86,0	82,04	28	60	12	0,76	30	70	16	0,95	40	70	16	1,25
PIG06B028	28	89,0	85,07	28	60	12	0,82	30	73	16	1,05	40	73	16	1,40
PIG06B029	29	89,0	88,09	28	60	12	0,93	30	76	16	1,15	40	76	16	1,50
PIG06B030	30	92,0	91,12	28	60	12	0,95	30	79	16	1,25	40	79	16	1,60
PIG06B031	31	94,7	94,15	30	65	14	1,00	30	80	16	1,35	40	80	16	1,70
PIG06B032	32	98,3	97,17	30	65	14	1,02	30	80	16	1,40	40	80	16	1,80
PIG06B033	33	101,3	100,20	30	65	14	1,05	30	80	16	1,45	40	80	16	1,90
PIG06B034	34	104,3	103,23	30	65	14	1,06	30	80	16	1,55	40	85	16	1,95
PIG06B035	35	107,3	106,26	30	65	14	1,10	30	80	16	1,60	40	85	16	2,00
PIG06B036	36	110,4	109,29	30	70	14	1,30	30	90	16	1,75	40	90	16	2,25
PIG06B037	37	113,4	112,32	30	70	14	1,32	30	90	16	1,85	40	90	16	2,30
PIG06B038	38	119,5	115,34	30	70	14	1,35	30	90	16	1,95	40	90	16	2,45
PIG06B039	39	122,5	118,37	30	70	14	1,37	30	90	16	2,00	40	90	16	2,55
PIG06B040	40	125,5	121,40	30	70	14	1,40	30	90	16	2,15	40	90	16	2,70
PIG06B045	45	141,1	136,54	35	78	16	1,70	50,5	88	20	2,30	60	88	20	3,20
PIG06B057	57	177,5	172,91	35	78	20	1,80	50,5	88	20	4,60	60	88	25	4,30
PIG06B076	76	235,1	230,49	35	78	20	2,39	50,5	88	25	5,70	60	88	25	10,00
RF06B038	38	119,5	115,35	32	70	20	1,20	40	80	20	1,80	56	90	24	2,20
RF06B045	45	140,7	136,55	32	70	20	1,50	40	80	20	2,20	56	90	24	3,20
RF06B057	57	176,9	172,91	32	70	20	1,90	40	80	20	2,50	56	90	24	3,80
RF06B076	76	234,9	230,49	32	70	20	2,60	40	80	20	3,60	56	100	24	4,80
RF06B095	95	292,5	288,08	40	80	20	3,20	45	90	20	4,10	56	100	24	5,50
RF06B114	114	349,6	345,68	40	80	20	4,20	45	90	20	5,50	56	100	24	8,00
RF06B150	150	459,2	454,82	45	90	24	4,50	50	100	24	7,30	60	125	24	10,5

(1) : Préciser PIG + S : simple, D : double, T : triple + Code  
M\* : Masse

Page 3

**081**  
**083**  
**085**

Pignon avec moyeu déporté pour  
Chaîne Simple, Double et Triple.  
081 ~ 1/2" x 1/8" ~ 12,7 x 3,3 mm  
083 ~ 1/2 x 3/16" ~ 12,7 x 4,88 mm  
085 ~ ~ 12,7 x 6,4 mm

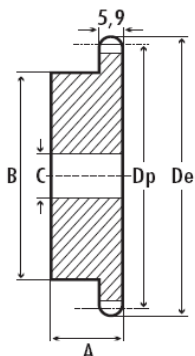
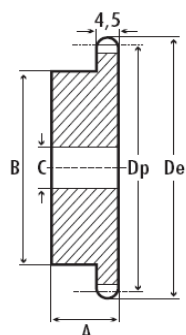
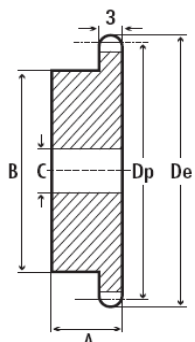

ACIER C43	081							083					085					
	REF	Z	De	Dp	A	B	C	M*	De	Dp	A	B	C	M*	De	Dp	A	B
PIG..... 008	8	37,20	33,18	14	21	8	0,04	38,50	33,18	14	21	8	0,04	38,50	33,18	10	25	20
PIG..... 009	9	41,50	37,13	14	25	8	0,05	41,50	37,13	14	25	8	0,06	41,50	37,13	10	25	24
PIG..... 010	10	46,20	41,10	14	28	8	0,07	46,20	41,10	14	28	8	0,08	46,20	41,10	10	25	26
PIG..... 011	11	49,60	45,07	16	31	8	0,10	49,60	45,07	16	31	8	0,09	49,60	45,07	10	25	29
PIG..... 012	12	53,90	49,07	16	35	8	0,11	53,90	49,07	16	35	8	0,13	53,90	49,07	10	28	33
PIG..... 013	13	58,40	53,06	16	39	8	0,16	58,40	53,06	16	39	8	0,16	58,40	53,06	10	28	37
PIG..... 014	14	62,80	57,07	16	43	8	0,19	62,80	57,07	16	43	8	0,20	62,80	57,07	10	28	41
PIG..... 015	15	66,80	61,09	16	47	8	0,21	66,80	61,09	16	47	8	0,23	66,80	61,09	10	28	45
PIG..... 016	16	70,90	65,10	18	50	10	0,28	70,90	65,10	18	50	10	0,30	70,90	65,10	12	28	50
PIG..... 017	17	74,90	69,11	18	50	10	0,30	74,90	69,11	18	50	10	0,31	74,90	69,11	12	28	52
PIG..... 018	18	78,90	73,14	18	50	10	0,31	78,90	73,14	18	50	10	0,33	78,90	73,14	12	28	56
PIG..... 019	19	82,90	77,16	18	50	10	0,31	82,90	77,16	18	50	10	0,34	82,90	77,16	12	28	60
PIG..... 020	20	86,90	81,19	18	50	10	0,45	86,90	81,19	18	50	10	0,37	86,90	81,19	12	28	64
PIG..... 021	21	91,00	85,22	20	60	12	0,48	91,00	85,22	20	60	12	0,51	91,00	85,22	14	28	68
PIG..... 022	22	95,00	89,24	20	60	12	0,50	95,00	89,24	20	60	12	0,53	95,00	89,24	14	28	70
PIG..... 023	23	99,00	93,27	20	60	12	0,51	99,00	93,27	20	60	12	0,55	99,00	93,27	14	28	70
PIG..... 024	24	103,00	97,29	20	60	12	0,52	103,00	97,29	20	60	12	0,56	103,00	97,29	14	28	70
PIG..... 025	25	107,10	101,33	20	60	12	0,53	107,10	101,33	20	60	12	0,58	107,10	101,33	14	28	70
PIG..... 026	26	111,20	105,36	20	70	16	0,67	111,20	105,36	20	70	16	0,72	111,20	105,36	16	30	70
PIG..... 027	27	115,40	109,40	20	70	16	0,68	115,40	109,40	20	70	16	0,75	115,40	109,40	16	30	70
PIG..... 028	28	119,40	113,42	20	70	16	0,68	119,40	113,42	20	70	16	0,77	119,40	113,42	16	30	70
PIG..... 029	29	123,40	117,46	20	70	16	0,72	123,40	117,46	20	70	16	0,79	123,40	117,46	16	30	80
PIG..... 030	30	127,50	121,50	20	70	16	0,75	127,50	121,50	20	70	16	0,81	127,50	121,50	16	30	80
PIG..... 031	31	131,50	125,54	20	70	16	0,77	131,50	125,54	20	70	16	0,85	131,50	125,54	16	30	90
PIG..... 032	32	135,50	129,56	20	70	16	0,79	135,50	129,56	20	70	16	0,87	135,50	129,56	16	30	90
PIG..... 033	33	139,60	133,60	20	70	16	0,81	139,60	133,60	20	70	16	0,89	139,60	133,60	16	30	90
PIG..... 034	34	143,60	137,64	20	70	16	0,91	143,60	137,64	20	70	16	0,91	143,60	137,64	16	30	90
PIG..... 035	35	147,60	141,68	20	70	16	0,94	147,60	141,68	20	70	16	0,93	147,60	141,68	16	30	90
PIG..... 036	36	151,70	145,72	25	70	16	0,96	151,70	145,72	25	70	16	0,96	151,70	145,72	16	35	90
PIG..... 037	37	155,70	149,76	25	70	16	1,07	155,70	149,76	25	70	16	0,98	155,70	149,76	16	35	90
PIG..... 038	38	159,80	153,80	25	70	16	1,10	159,80	153,80	25	70	16	1,15	159,80	153,80	16	35	90
PIG..... 039	39	163,80	157,83	25	70	16	1,13	163,80	157,83	25	70	16	1,18	163,80	157,83	16	35	90
PIG..... 040	40	167,80	161,87	25	70	16	1,16	167,80	161,87	25	70	16	1,24	167,80	161,87	16	35	90

(.....) : Préciser 081 ~083~085  
M\* : Masse

# 08B

Pignon avec moyeu déporté pour  
Chaîne Simple, Double et Triple.  
1/2" ~ 12,7 x 7,75 mm

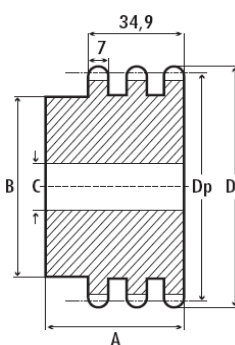
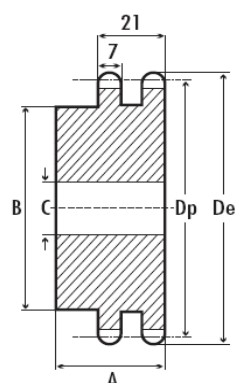
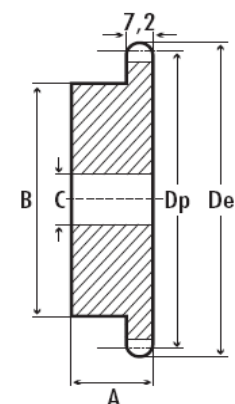

ACIER C43

Pignon Simple

Pignon Double

Pignon Triple

REF(1)	Z	De	Dp	A	B	C	M*	A	B	C	M*	A	B	C	M*
PIG08B008	8	37,20	33,18	25	20	10	0,07	32	20	10	0,15	46	20	10	0,15
PIG08B009	9	41,00	37,13	25	24	10	0,10	32	24	10	0,15	46	24	12	0,19
PIG08B010	10	45,20	41,10	25	26	10	0,14	32	28	10	0,19	46	28	12	0,26
PIG08B011	11	48,70	45,07	25	29	10	0,16	35	32	12	0,27	50	32	16	0,30
PIG08B012	12	53,00	49,07	28	33	10	0,22	35	35	12	0,32	50	35	16	0,38
PIG08B013	13	57,40	53,06	28	37	10	0,28	35	38	12	0,37	50	38	16	0,59
PIG08B014	14	61,80	57,07	28	41	10	0,33	35	42	12	0,44	50	42	16	0,71
PIG08B015	15	65,50	61,09	28	45	10	0,40	35	46	12	0,50	50	46	16	0,82
PIG08B016	16	69,50	65,10	28	50	12	0,48	38	50	14	0,62	50	50	16	0,96
PIG08B017	17	73,60	69,11	28	52	12	0,55	38	54	14	0,72	50	54	16	1,05
PIG08B018	18	77,80	73,14	28	56	12	0,60	38	58	14	0,86	50	58	16	1,25
PIG08B019	19	81,70	77,16	28	60	12	0,69	38	62	14	0,93	50	62	16	1,35
PIG08B020	20	85,80	81,19	28	64	12	0,77	38	66	14	1,05	50	66	16	1,50
PIG08B021	21	89,70	85,22	28	68	14	0,88	40	70	16	1,15	55	70	20	1,70
PIG08B022	22	93,80	89,24	28	70	14	0,93	40	70	16	1,40	55	70	20	2,00
PIG08B023	23	98,20	93,27	28	70	14	0,95	40	70	16	1,60	55	70	20	2,25
PIG08B024	24	101,80	97,29	28	70	14	1,00	40	75	16	1,70	55	75	20	2,40
PIG08B025	25	105,80	101,33	28	70	14	1,05	40	80	16	1,95	55	80	20	2,75
PIG08B026	26	110,00	105,36	30	70	16	1,10	40	85	20	2,10	55	85	20	2,95
PIG08B027	27	114,00	109,40	30	70	16	1,15	40	85	20	2,20	55	85	20	3,15
PIG08B028	28	118,00	113,42	30	70	16	1,20	40	90	20	2,40	55	90	20	3,40
PIG08B029	29	122,00	117,46	30	80	16	1,40	40	95	20	2,60	55	95	20	3,75
PIG08B030	30	126,21	121,50	30	80	16	1,50	40	100	20	2,80	55	100	20	4,00
PIG08B031	31	130,20	125,54	30	90	16	1,70	40	100	20	3,20	55	110	20	4,55
PIG08B032	32	134,30	129,56	30	90	16	1,75	40	100	20	3,35	55	110	20	4,75
PIG08B033	33	138,40	133,60	30	90	16	1,80	40	100	20	3,50	55	110	20	4,95
PIG08B034	34	142,60	137,64	30	90	16	1,85	40	100	20	3,60	55	110	20	5,15
PIG08B035	35	146,70	141,68	30	90	16	1,90	40	100	20	3,75	55	110	20	5,40
PIG08B036	36	151,00	145,72	35	90	20	2,25	40	110	20	4,10	55	120	25	5,95
PIG08B037	37	154,60	149,76	35	90	20	2,30	40	110	20	1,25	55	120	25	6,15
PIG08B038	38	158,60	153,80	35	90	20	2,35	40	110	20	4,45	55	120	25	6,35
PIG08B039	39	162,70	157,83	35	90	20	2,40	40	110	20	4,60	55	120	25	6,65
PIG08B040	40	166,80	161,87	35	90	20	2,45	40	110	20	4,75	55	120	25	7,00
PIG08B045	45	188,60	182,07	42	88	20	3,20	55	108	25	6,20	55	120	25	9,30
PIG08B057	57	237,10	230,54	42	88	20	4,00	55	108	25	9,00	55	120	25	13,50
PIG08B076	76	313,19	307,33	42	88	25	6,40	55	108	25	14,50	55	120	25	23,00
RF08B038	38	158,6	153,80	40	70	24	2,70	50	90	24	3,10	60	100	24	4,50
RF08B045	45	188,0	182,07	40	70	24	3,20	50	90	24	3,50	60	100	24	5,30
RF08B057	57	236,4	230,54	40	70	24	4,00	50	90	24	4,40	60	100	24	5,70
RF08B076	76	313,3	307,33	40	80	24	5,20	56	100	24	6,20	60	100	24	9,00
RF08B095	95	390,1	384,11	45	80	24	5,70	56	100	24	9,00	67	120	24	12,40
RF08B114	114	466,3	460,90	45	80	24	7,00	63	100	24	11,00	67	120	24	15,10

(1) : Préciser PIG + S : simple, D : double, T : triple + Code  
M\* : Masse

# 10B

Pignon avec moyeu déporté pour  
Chaîne Simple, Double et Triple.  
5/8" ~ 15,875 x 9,65 mm



ACIER C43

Pignon Simple

Pignon Double

Pignon Triple

REF(1)	Z	De	Dp	A	B	C	M*	A	B	C	M*	A	B	C	M*
PIG10B008	8	47,00	41,48	25	25	10	0,13	40	25	12	0,20	55	25	12	0,25
PIG10B009	9	52,60	46,42	25	30	10	0,18	40	30	12	0,27	55	30	12	0,35
PIG10B010	10	57,50	51,37	25	35	10	0,24	40	35	12	0,33	55	35	16	0,46
PIG10B011	11	63,00	56,34	30	37	12	0,32	40	39	14	0,44	55	39	16	0,57
PIG10B012	12	68,00	61,34	30	42	12	0,40	40	44	14	0,58	55	44	16	0,73
PIG10B013	13	73,00	66,32	30	47	12	0,48	40	49	14	0,72	55	49	16	0,98
PIG10B014	14	78,00	71,34	30	52	12	0,59	40	49	14	0,87	55	49	16	1,20
PIG10B015	15	83,00	76,36	30	57	12	0,68	40	54	14	0,99	55	54	16	1,35
PIG10B016	16	88,00	81,37	30	60	14	0,76	45	59	14	1,30	60	59	16	1,55
PIG10B017	17	93,00	86,39	30	60	14	0,81	45	64	16	1,45	60	64	16	1,80
PIG10B018	18	98,30	91,42	30	70	14	0,90	45	69	16	1,70	60	69	16	2,40
PIG10B019	19	103,30	96,45	30	70	14	1,05	45	74	16	1,85	60	74	16	2,45
PIG10B020	20	108,40	101,49	30	75	14	1,20	45	79	16	2,20	60	79	16	2,90
PIG10B021	21	113,40	106,52	30	75	16	1,25	45	84	16	2,35	60	84	16	2,95
PIG10B022	22	118,00	111,55	30	80	16	1,40	45	85	16	2,60	60	85	20	3,55
PIG10B023	23	123,40	116,58	30	80	16	1,45	45	90	16	2,90	60	90	20	3,95
PIG10B024	24	128,30	121,62	30	80	16	1,50	45	95	16	3,20	60	95	20	4,35
PIG10B025	25	134,00	126,66	30	80	16	1,60	45	100	16	3,45	60	100	20	4,65
PIG10B026	26	139,00	131,70	35	85	20	1,85	45	105	16	3,85	60	105	20	5,05
PIG10B027	27	144,00	136,75	35	85	20	1,95	45	110	20	4,00	60	110	20	5,40
PIG10B028	28	148,70	141,78	35	90	20	2,30	45	110	20	4,35	60	110	20	5,95
PIG10B029	29	153,80	146,83	35	90	20	2,35	45	115	20	4,40	60	115	20	6,25
PIG10B030	30	158,80	151,87	35	90	20	2,45	45	115	20	4,95	60	115	20	6,70
PIG10B031	31	163,90	156,92	35	95	20	2,65	45	120	20	5,25	60	120	20	7,10
PIG10B032	32	168,90	161,95	35	95	20	2,70	45	120	20	5,50	60	120	20	7,50
PIG10B033	33	174,50	167,00	35	95	20	2,80	45	120	20	5,80	60	120	20	7,85
PIG10B034	34	179,00	172,05	35	95	20	2,85	45	120	20	6,05	60	120	20	8,25
PIG10B035	35	184,10	177,10	35	95	20	2,90	45	120	20	6,30	60	120	20	8,65
PIG10B036	36	189,10	182,15	35	100	20	3,30	45	120	20	6,55	60	120	25	9,15
PIG10B037	37	194,20	187,20	35	100	20	3,40	45	120	20	6,80	60	120	25	9,65
PIG10B038	38	199,20	192,24	35	100	20	3,50	45	120	20	7,03	60	120	25	
PIG10B039	39	204,20	197,29	35	100	20	3,60	45	120	20	7,25	60	120	25	
PIG10B040	40	209,30	202,34	35	100	20	3,70	45	120	20	7,55	60	120	25	
PIG10B045	45	236,00	227,58	40	100	20	6,00	50	130	25	8,50	60	120	25	
PIG10B057	57	296,60	288,18	40	100	25	7,50	50	130	25	10,90	60	120	25	
PIG10B076	76	392,50	384,16	40	100	25	9,99	50	130	25	15,90	60	120	25	
RF10B038	38	199,20	192,24	40	80	24	2,90	50	100	30	4,90	60	100	32	6,30
RF10B045	45	235,00	227,58	40	80	24	3,40	50	100	30	5,20	60	100	32	7,50
RF10B057	57	296,00	288,18	45	90	24	4,00	56	100	30	6,30	63	100	32	9,50
RF10B076	76	392,10	384,16	50	90	24	6,40	63	100	30	9,90	67	110	35	14,50
RF10B095	95	488,50	480,14	56	100	24	8,50	63	110	30	13,50	70	125	35	18,50
RF10B114	114	584,10	576,13	56	100	24	14,00	70	125	30	18,00	80	125	35	25,00

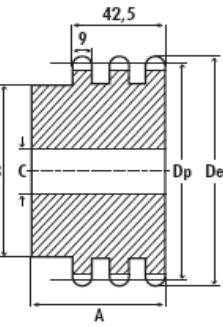
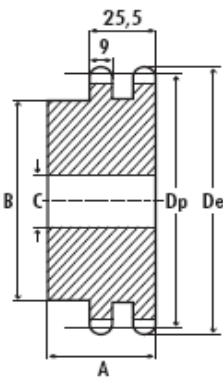
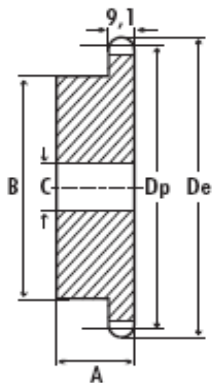

(1) : Préciser PIG + S : simple, D : double, T : triple + Code  
M\* : Masse

# 12B

Pignon avec moyeu déporté pour  
Chaîne Simple, Double et Triple.  
3/4" ~ 19,05 x 11,68 mm



ACIER C43

Pignon Simple

Pignon Double

Pignon Triple

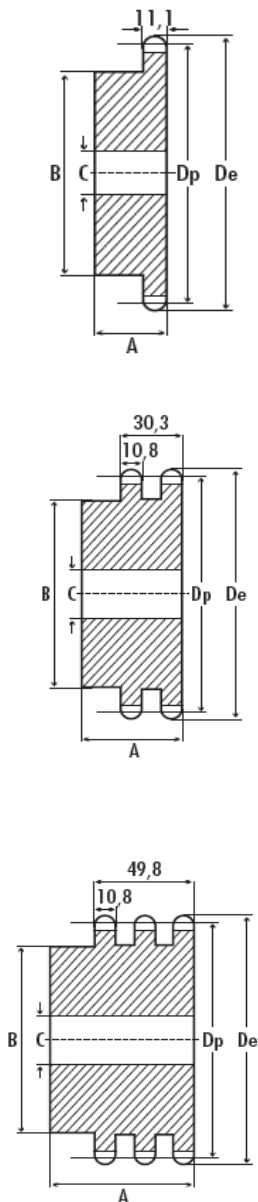

REF(1)	Z	De	Dp	A	B	C	M*	A	B	C	M*	A	B	C	M*
PIG12B008	8	57,60	49,78	30	31	12	0,20	45	31	12	0,30	65	31	16	0,40
PIG12B009	9	62,00	55,70	30	37	12	0,30	45	37	12	0,45	65	37	16	0,68
PIG12B010	10	69,00	61,64	30	42	12	0,40	45	42	12	0,64	65	42	16	0,91
PIG12B011	11	75,00	67,61	35	46	14	0,57	50	47	16	0,89	70	47	20	1,20
PIG12B012	12	81,50	73,60	35	52	14	0,70	50	53	16	1,10	70	53	20	1,65
PIG12B013	13	87,50	79,59	35	58	14	0,80	50	59	16	1,30	70	59	20	1,90
PIG12B014	14	93,60	85,61	35	64	14	1,00	50	65	16	1,60	70	65	20	2,25
PIG12B015	15	99,80	91,63	35	70	14	1,10	50	71	16	1,80	70	71	20	2,60
PIG12B016	16	105,50	97,65	35	75	16	1,35	50	77	20	2,15	70	77	20	3,05
PIG12B017	17	111,50	103,67	35	80	16	1,45	50	83	20	2,55	70	83	20	3,50
PIG12B018	18	118,00	109,71	35	80	16	1,55	50	89	20	3,10	70	89	20	4,10
PIG12B019	19	124,20	115,75	35	80	16	1,65	50	95	20	3,35	70	95	20	4,50
PIG12B020	20	129,70	121,78	35	80	16	1,75	50	100	20	3,85	70	100	20	4,90
PIG12B021	21	136,00	127,82	40	90	20	1,95	50	100	20	4,05	70	100	20	5,50
PIG12B022	22	141,80	133,86	40	90	20	2,45	50	100	20	4,30	70	100	20	5,95
PIG12B023	23	149,00	139,90	40	90	20	2,60	50	110	20	4,80	70	110	20	6,75
PIG12B024	24	153,90	145,94	40	90	20	2,65	50	110	20	5,00	70	110	20	7,10
PIG12B025	25	160,00	152,00	40	90	20	2,80	50	120	20	5,55	70	120	20	7,95
PIG12B026	26	165,90	158,04	40	95	20	3,15	50	120	20	5,90	70	120	20	8,50
PIG12B027	27	172,30	164,09	40	95	20	3,20	50	120	20	6,20	70	120	20	9,00
PIG12B028	28	178,00	170,13	40	95	20	3,35	50	120	20	6,55	70	120	20	9,60
PIG12B029	29	184,10	176,19	40	95	20	3,55	50	120	20	6,90	70	120	20	10,20
PIG12B030	30	190,50	182,25	40	95	20	3,70	50	120	20	7,20	70	120	20	10,70
PIG12B031	31	196,30	188,31	40	100	20	3,80	50	120	20	7,80	70	130	25	11,70
PIG12B032	32	203,30	194,35	40	100	20	3,90	50	120	20	8,25	70	130	25	12,30
PIG12B033	33	209,30	200,40	40	100	20	4,10	50	120	20	8,65	70	130	25	13,10
PIG12B034	34	214,60	206,46	40	100	20	4,20	50	120	20	9,10	70	130	25	13,90
PIG12B035	35	221,00	212,52	40	100	20	4,35	50	120	20	9,45	70	130	25	14,40
PIG12B036	36	226,80	218,58	40	100	25	4,70	50	120	25	9,90	70	130	25	15,30
PIG12B037	37	232,90	224,64	40	100	25	5,10	50	120	25	10,40	70	130	25	16,10
PIG12B038	38	239,00	230,69	40	100	25	5,20	50	120	25	10,80	70	130	25	16,90
PIG12B039	39	245,10	236,75	40	100	25	5,25	50	120	25	11,40	70	130	25	17,90
PIG12B040	40	251,30	242,81	40	100	25	5,40	50	120	25	11,90	70	130	25	18,60
PIG12B045	45	283,20	273,10	40	100	25	5,00	60	130	25	13,40	70	140	25	20,92
PIG12B050	50	312,30	303,39	40	100	25	5,80	50	120	25	14,30	70	140	25	23,25
PIG12B057	57	355,90	345,81	40	100	25	6,65	50	130	25	15,80	70	140	30	26,50
PIG12B065	65	403,20	394,21	40	100	25	8,50	50	120	30	16,50	70	140	30	30,22
PIG12B076	76	469,90	460,99	56	110	25	10,00	63	140	30	17,00	70	140	30	35,34
RF12B038	38	239,00	230,69	56	100	24	4,50	63	110	30	6,30	70	140	30	10,60
RF12B045	45	282,50	273,10	56	100	24	5,50	63	110	30	7,50	70	140	30	12,60
RF12B057	57	354,00	245,80	56	100	30	7,00	63	120	30	10,00	70	140	40	15,50
RF12B076	76	469,90	461,00	56	100	30	9,80	63	135	30	15,00	75	160	40	21,80
RF12B095	95	585,10	576,20	65	100	30	12,00	70	135	30	20,00	82	170	40	30,00
RF12B114	114	700,60	691,40	65	100	30	19,00	70	135	30	26,00	82	170	40	38,00

(1) : Préciser PIG + S : simple, D : double, T : triple + Code  
M\* : Masse

Page 7

# 16B

Pignon avec moyeu déporté pour  
Chaîne Simple, Double et Triple.  
1" ~ 25,4 x 17,02 mm



ACIER C43

Pignon Simple

Pignon Double

Pignon Triple

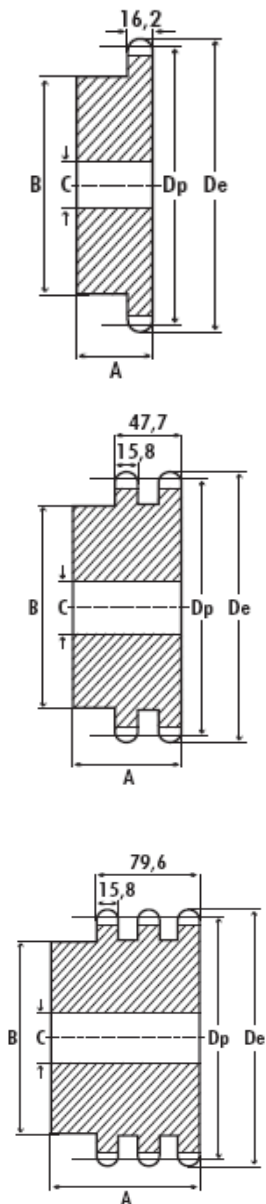

REF(1)	Z	De	Dp	A	B	C	M*	A	B	C	M*	A	B	C	M*
PIG16B008	8	77,00	66,37	35	42	16	0,50	65	42	16	0,60	95	42	20	1,32
PIG16B009	9	85,00	74,27	35	50	16	0,70	65	50	16	1,20	95	50	20	1,83
PIG16B010	10	93,00	82,19	35	55	16	0,85	65	56	16	1,70	95	56	20	2,35
PIG16B011	11	99,50	90,14	40	61	16	1,10	70	64	20	2,15	100	64	25	2,80
PIG16B012	12	109,00	98,14	40	69	16	1,45	70	72	20	2,65	100	72	25	3,70
PIG16B013	13	117,00	106,12	40	78	16	1,75	70	80	20	3,40	100	80	25	4,42
PIG16B014	14	125,00	114,15	40	84	16	2,05	70	88	20	3,95	100	88	25	5,42
PIG16B015	15	133,00	122,17	40	92	16	2,25	70	96	20	4,45	100	96	25	7,00
PIG16B016	16	141,00	130,20	45	100	20	2,90	70	104	25	5,25	100	104	30	8,00
PIG16B017	17	149,00	138,22	45	100	20	3,05	70	112	25	5,85	100	112	30	8,54
PIG16B018	18	157,00	146,28	45	100	20	3,50	70	120	25	7,00	100	120	30	9,70
PIG16B019	19	165,20	154,33	45	100	20	3,60	70	128	25	7,70	100	128	30	10,87
PIG16B020	20	173,20	162,38	45	100	20	3,80	70	130	25	8,90	100	130	30	12,25
PIG16B021	21	181,20	170,43	50	110	20	4,30	70	130	25	9,75	100	130	30	13,40
PIG16B022	22	189,30	178,48	50	110	20	4,55	70	130	25	10,30	100	130	30	14,00
PIG16B023	23	197,50	186,53	50	110	20	4,90	70	130	25	11,20	100	130	30	16,00
PIG16B024	24	205,50	194,59	50	110	20	5,05	70	130	25	12,00	100	130	30	17,18
PIG16B025	25	213,50	202,66	50	110	20	5,25	70	130	25	12,70	100	130	30	18,70
PIG16B026	26	221,60	210,72	50	120	20	6,40	70	130	25	13,80	100	130	30	20,37
PIG16B027	27	229,60	218,79	50	120	20	6,65	70	130	25	14,50	100	130	30	21,87
PIG16B028	28	237,70	226,85	50	120	20	6,95	70	130	25	15,60	100	130	30	23,65
PIG16B029	29	245,80	234,92	50	120	20	7,40	70	130	25	16,40	100	130	30	25,36
PIG16B030	30	254,00	243,00	50	120	20	7,65	70	130	25	17,40	100	130	30	27,04
PIG16B031	31	262,00	251,08	50	120	25	8,00	70	140	25	18,60	100	140	30	29,10
PIG16B032	32	270,00	259,13	50	120	25	8,40	70	140	25	19,60	100	140	30	31,10
PIG16B033	33	278,50	267,21	50	120	25	8,75	70	140	25	20,90	100	140	30	33,10
PIG16B034	34	287,00	275,28	50	120	25	9,25	70	140	25	22,00	100	140	30	35,00
PIG16B035	35	296,20	283,36	50	120	25	9,60	70	140	25	23,10	100	140	30	36,66
PIG16B036	36	304,60	291,44	50	120	25	9,95	70	140	25	24,70	100	140	30	39,64
PIG16B037	37	312,60	299,51	50	120	25	10,30	70	140	25	25,80	100	140	30	40,80
PIG16B038	38	320,70	307,59	50	120	25	10,70	70	140	25	27,20	100	140	30	42,50
PIG16B039	39	328,80	315,67	50	120	25	11,30	70	140	25	28,40	100	140	30	43,00
PIG16B040	40	336,90	323,73	50	120	25	11,90	70	140	25	29,90	100	140	30	44,50
PIG16B045	45	377,90	364,12	70	125	25	13,38	80	150	25	33,63	100	150	30	
PIG16B050	50	417,40	404,52	70	125	25	14,87	80	150	30	37,37	100	150	30	
PIG16B057	57	474,90	461,07	70	125	30	16,95	90	160	30	42,60	110	160	40	
PIG16B065	65	538,80	525,73	80	140	30	19,33	90	160	30	48,58	110	160	40	
PIG16B076	76	628,40	614,65	80	140	30	22,61	90	160	30	56,81	110	160	40	
RF16B038	38	320,00	307,59	65	110	30	8,20	75	140	40	15,10	100	160	45	22,20
RF16B045	45	377,00	364,12	70	125	30	10,00	75	150	40	18,00	100	160	45	27,00
RF16B057	57	474,00	461,07	70	125	35	14,70	90	170	40	24,50	100	165	45	39,50
RF16B076	76	627,00	614,65	80	140	35	22,00	95	175	40	37,00	110	200	45	56,00
RF16B095	95	781,00	768,22	80	140	40	33,00	95	175	45	52,00	110	200	50	82,00
RF16B114	114	933,00	921,81	80	140	40	45,00	95	175	45		115	200	50	105,00

(1) : Préciser PIG + S : simple, D : double, T : triple + Code  
M\* : Masse



# 20B

Pignon avec moyeu déporté pour  
Chaîne Simple, Double et Triple.  
1" 1/4 ~ 31,75 x 19,56 mm



ACIER C43

Pignon Simple

Pignon Double

Pignon Triple

REF(1)	Z	De	Dp	A	B	C	M*	A	B	C	M*	A	B	C	M*
PIG20B008	8	98,10	82,96	40	53	20	0,90	75	53	20	1,75	110	53	25	
PIG20B009	9	108,00	92,84	40	63	20	1,25	75	63	20	2,75	110	63	25	
PIG20B010	10	117,90	102,74	40	70	20	1,75	75	70	20	3,60	110	70	25	
PIG20B011	11	127,80	112,68	45	77	20	2,25	80	80	25	4,75	115	80	30	
PIG20B012	12	137,80	122,68	45	88	20	2,75	80	90	25	5,70	115	90	30	
PIG20B013	13	147,80	132,65	45	98	20	3,30	80	100	25	6,75	115	100	30	
PIG20B014	14	157,80	142,68	45	108	20	4,10	80	110	25	8,00	115	110	30	
PIG20B015	15	167,90	152,72	45	118	20	5,25	80	120	25	10,00	115	120	30	
PIG20B016	16	177,90	162,75	50	120	25	5,50	80	120	30	11,20	115	120	30	
PIG20B017	17	187,90	172,78	50	120	25	5,80	80	120	30	12,20	115	120	30	
PIG20B018	18	198,00	182,85	50	120	25	6,20	80	120	30	13,50	115	120	30	
PIG20B019	19	208,10	192,91	50	120	25	6,50	80	120	30	14,50	115	120	30	
PIG20B020	20	218,10	202,98	50	120	25	7,00	80	120	30	15,80	115	120	30	
PIG20B021	21	228,20	213,04	55	140	30	9,00	80	140	30	17,20	115	140	30	
PIG20B022	22	238,30	223,11	55	140	30	9,50	80	140	30	18,50	115	140	30	
PIG20B023	23	248,30	233,17	55	140	30	10,00	80	140	30	20,00	115	140	30	
PIG20B024	24	258,40	243,23	55	140	30	10,50	80	140	30	21,50	115	140	30	
PIG20B025	25	268,50	253,33	55	140	30	11,60	80	140	30	24,00	115	140	30	
PIG20B026	26	278,60	263,40	55	150	30	12,10	80	150	30	27,00	115	150	30	
PIG20B027	27	288,60	273,48	55	150	30	12,80	80	150	30	28,50	115	150	30	
PIG20B028	28	298,70	283,56	55	150	30	13,40	80	150	30	30,50	115	150	30	
PIG20B029	29	308,80	293,65	55	150	30	14,10	80	150	30	32,20	115	150	30	
PIG20B030	30	318,90	303,75	55	150	30	14,50	80	150	30	34,00	115	150	30	
PIG20B031	31	329,00	313,85	55	160	30	15,20	80	150	30	36,00	115	150	30	
PIG20B032	32	339,10	323,91	55	160	30	16,10	80	150	30	38,50	115	150	30	
PIG20B033	33	349,20	334,01	55	160	30	16,80	80	150	30	40,70	115	150	30	
PIG20B034	34	359,30	334,10	55	160	30	17,50	80	150	30	43,10	115	150	30	
PIG20B035	35	369,40	354,20	55	160	30	18,50	80	150	30	45,00	115	150	30	
PIG20B036	36	379,50	364,30	55	160	30	19,00	80	150	30	47,50	115	150	30	
PIG20B037	37	389,50	374,39	55	160	30	20,00	80	150	30	50,00	115	150	30	
PIG20B038	38	399,60	384,49	55	160	30	20,50	80	150	30	53,50	115	150	30	
PIG20B039	39	409,70	394,59	55	160	30	21,50	80	150	30	55,00	115	150	30	
PIG20B040	40	419,80	404,66	55	160	30	22,50	80	150	30	57,50	115	150	30	
PIG20B045	45	471,10	455,17	70	150	30	25,31	80	150	30	64,68	115	150	30	
PIG20B050	50	520,80	505,65	70	150	30	28,12	90	160	30	71,87	110	180	40	
PIG20B057	57	591,50	576,36	80	150	30	32,05	100	160	30	81,93	125	180	40	
PIG20B065	65	672,30	657,16	80	150	30	36,55	100	160	30	93,43	125	180	40	
PIG20B076	76	783,50	768,32	90	150	30	42,74	100	180	30	98,00	140	200	40	
RF20B038	38	399,60	384,49	70	125	35		90	140	45	30,40	110	180	56	49,40
RF20B045	45	470,30	455,17	70	125	35		90	140	45	40,00	110	180	56	65,00
RF20B057	57	591,50	576,36	80	135	40		100	160	50	65,00	125	180	63	94,00
RF20B076	76	783,50	768,32	90	140	50		100	180	56	86,60	140	200	63	125,30
RF20B095	95	975,50	960,27	100	190	50		130	200	50		140	210	50	
RF20B114	114	11167,30	1152,26	110	200	50		140	200	50		160	200	50	

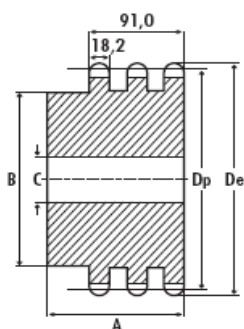
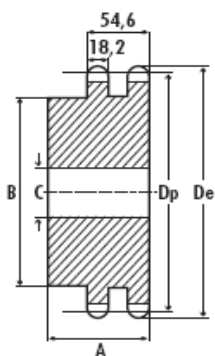
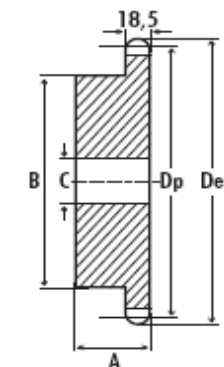

(1) : Préciser PIG + S : simple, D : double, T : triple + Code  
M\* : Masse

# 24B

Pignon avec moyeu déporté pour  
Chaîne Simple, Double et Triple.  
1" 1/2 ~ 38,1 x 25,4 mm

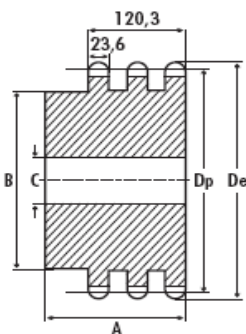
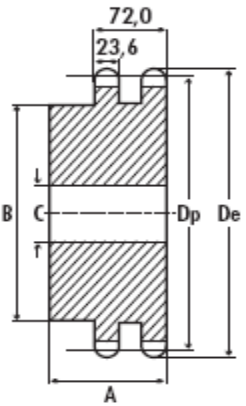
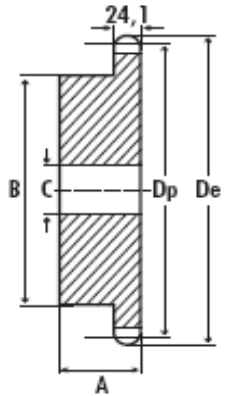

ACIER C43				Pignon Simple				Pignon Double				Pignon Triple			
REF(1)	Z	De	Dp	A	B	C	M*	A	B	C	M*	A	B	C	M*
PIG24B008	8	115,00	99,55	45	58	20	1,60	95	58	25	2,90	140	58	25	
PIG24B009	9	126,40	111,40	45	70	20	1,95	95	70	25	4,00	140	70	25	
PIG24B010	10	138,00	123,29	45	80	20	2,40	95	80	25	5,10	140	80	25	
PIG24B011	11	150,00	135,21	50	90	25	3,40	100	90	25	6,70	150	90	30	
PIG24B012	12	162,00	147,22	50	102	25	4,10	100	102	25	8,40	150	102	30	
PIG24B013	13	174,20	159,18	50	114	25	4,70	100	114	25	10,20	150	114	30	
PIG24B014	14	186,20	171,22	50	128	25	6,10	100	128	25	12,30	150	128	30	
PIG24B015	15	198,20	183,26	50	140	25	7,00	100	140	25	14,30	150	132	30	
PIG24B016	16	210,30	195,30	55	140	25	8,30	100	150	30	16,80	150	136	30	
PIG24B017	17	222,30	207,34	55	140	25	8,90	100	150	30	18,80	150	140	30	
PIG24B018	18	234,30	219,42	55	140	25	9,70	100	150	30	21,00	150	150	30	
PIG24B019	19	246,50	231,49	55	140	25	10,40	100	160	30	23,00	150	160	30	
PIG24B020	20	258,60	243,57	55	140	25	11,20	100	160	30	25,50	150	160	30	
PIG24B021	21	270,60	255,65	60	150	30	13,30	100	160	30	28,00	150	160	40	
PIG24B022	22	282,70	267,73	60	150	30	14,20	100	160	30	30,50	150	160	40	
PIG24B023	23	294,80	279,80	60	150	30	15,20	100	160	30	33,00	150	160	40	
PIG24B024	24	306,80	291,88	60	150	30	16,10	100	160	30	35,00	150	160	40	
PIG24B025	25	319,00	304,00	60	150	30	17,00	100	160	30	37,50	150	160	40	
PIG24B026	26	331,00	316,08	60	160	30	18,60	100	160	30	41,00	150	160	40	
PIG24B027	27	343,20	328,19	60	160	30	19,70	100	160	30	44,50	150	160	40	
PIG24B028	28	355,20	340,27	60	160	30	20,70	100	160	30	47,50	150	160	40	
PIG24B029	29	367,30	352,38	60	160	30	21,90	100	160	30	51,00	150	160	40	
PIG24B030	30	379,50	364,50	60	160	30	23,00	100	160	30	54,00	150	160	40	
PIG24B031	31	391,60	376,62	60	160	30	24,50	100	170	30	58,00	150	160	40	
PIG24B032	32	403,70	388,69	60	160	30	25,80	100	170	30	62,00	150	160	40	
PIG24B033	33	415,80	400,81	60	160	30	27,00	100	170	30	66,00	150	160	40	
PIG24B034	34	427,80	412,93	60	160	30	28,50	100	170	30	70,00	150	160	40	
PIG24B035	35	440,00	425,04	60	160	30	30,00	100	170	30	74,00	150	160	40	
PIG24B036	36	452,00	437,16	60	160	30	31,50	100	170	30	78,00	150	160	40	
PIG24B037	37	464,20	449,27	60	160	30	32,50	100	170	30	83,00	150	160	40	
PIG24B038	38	476,20	461,39	60	160	30	34,00	100	170	30	87,00	150	160	40	
PIG24B039	39	488,50	473,50	60	160	30	35,50	100	170	30	92,00	150	160	40	
PIG24B040	40	500,60	485,62	60	160	30	37,00	100	170	30	96,00	150	160	40	
PIG24B045	45	561,20	546,20	90	160	30	41,65	100	180	40	108,00	150	170	40	
PIG24B050	50	621,70	606,78	90	160	30	46,25	100	180	40	120,00	150	170	40	
PIG24B057	57	706,50	691,63	100	160	30	48,00	110	200	40	136,80	150	170	40	
PIG24B065	65	803,40	788,59	100	160	40	54,73	110	200	40	156,00	150	170	40	
PIG24B076	76	936,90	921,98	100	170	40	59,50	120	220	40	166,00	150	200	40	
RF24B038	38	476,20	461,39	90	140	45		100	180	45		150	200	60	87,40
RF24B045	45	561,20	546,20	90	140	45		100	180	45	76,00	150	200	60	120,00
RF24B057	57	706,50	691,63	100	160	45		110	200	55	113,00	150	200	70	172,00
RF24B076	76	936,90	921,98	100	170	45		120	220	55	159,00	150	230	55	230,00
RF24B095	95	1166,70	1152,33	125	200	50		140	220	55	200,00				280,00
RF24B114	114	1397,70	1382,72	110	200	50		180	300	50		200	300	50	

(1) : Préciser PIG + S : simple, D : double, T : triple + Code  
M\* : Masse

# 28B

Pignon avec moyeu déporté pour  
Chaîne Simple, Double et Triple.  
1" 3/4 ~ 44,45 x 30,99 mm



ACIER C43

Pignon Simple

Pignon Double

Pignon Triple

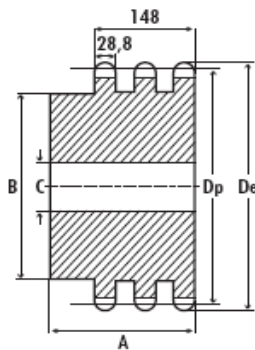
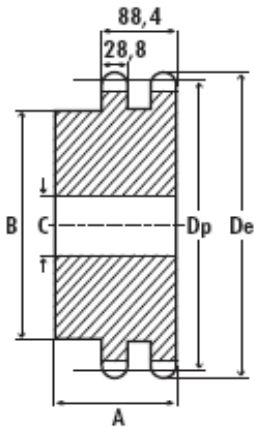
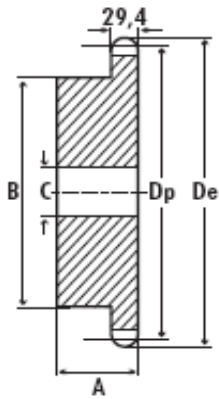

REF(1)	Z	De	Dp	A	B	C	M*	A	B	C	M*	A	B	C	M*
PIG28B008	8	132,00	116,15	70	74	25	3,10	120	74	30	5,50	180	74	30	
PIG28B009	9	148,40	129,96	70	88	25	4,20	120	88	30	7,20	180	88	30	
PIG28B010	10	162,30	143,85	70	100	25	5,40	120	100	30	9,50	180	100	30	
PIG28B011	11	176,30	157,77	70	112	25	6,60	120	112	30	11,50	180	112	30	
PIG28B012	12	189,50	171,74	70	125	25	8,10	120	125	30	13,80	180	125	30	
PIG28B013	13	204,20	185,75	70	125	25	9,00	120	125	30	16,00	180	125	30	
PIG28B014	14	218,20	199,76	70	130	25	10,50	120	130	30	18,80	180	130	30	
PIG28B015	15	232,30	213,79	70	145	25	12,00	120	145	30	21,80	180	145	30	
PIG28B016	16	246,30	227,84	75	160	30	15,00	120	160	30	25,50	180	160	30	
PIG28B017	17	260,00	241,90	75	160	30	16,00	120	160	30	28,00	180	160	30	
PIG28B018	18	274,00	255,98	75	160	30	17,00	120	160	30	31,00	180	160	30	
PIG28B019	19	289,00	270,06	75	160	30	18,50	120	180	30	36,00	180	180	30	
PIG28B020	20	303,00	284,15	75	160	30	20,00	120	180	30	39,80	180	180	30	
PIG28B021	21	317,00	298,24	75	170	30	22,00	120	180	30	42,80	180	180	40	
PIG28B022	22	331,00	312,34	75	170	30	23,50	120	180	30	46,80	180	180	40	
PIG28B023	23	345,00	326,44	75	170	30	25,00	120	180	30	50,50	180	180	40	
PIG28B024	24	359,00	340,55	75	170	30	26,50	120	180	30	52,69	180	180	40	
PIG28B025	25	373,00	354,66	75	170	30	28,00	120	180	30	59,00	180	180	40	
PIG28B026	26	387,00	368,77	75	170	30	29,50	120	180	40	61,36	180	180	40	
PIG28B027	27	401,00	382,88	75	170	30	30,03	120	180	40	63,72	180	180	40	
PIG28B028	28	416,00	397,00	75	170	30	32,50	120	180	40	66,08	180	180	40	
PIG28B029	29	430,00	411,12	75	170	30	33,66	120	180	40	68,44	180	180	40	
PIG28B030	30	444,00	425,24	75	170	30	38,00	120	180	40	70,80	180	180	40	
PIG28B031	31	439,37	458,00	75	180	30	39,26	120	200	40	73,16	180	200	40	
PIG28B032	32	472,00	453,49	75	180	30	40,53	120	200	40	75,52	180	200	40	
PIG28B033	33	486,00	467,62	75	180	30	41,79	120	200	40	77,88	180	200	40	
PIG28B034	34	500,00	481,75	75	180	30	44,33	120	200	40	80,24	180	200	40	
PIG28B035	35	514,00	495,88	75	180	30	51,00	120	200	40	82,60	180	200	40	
PIG28B036	36	529,00	510,01	75	180	30	52,45	120	200	40	84,96	180	200	40	
PIG28B037	37	543,00	524,13	75	180	30	53,91	120	200	40	87,32	180	200	40	
PIG28B038	38	557,00	538,27	75	180	30	59,00	120	200	40	89,68	180	200	40	
PIG28B039	39	571,00	552,40	75	180	30	64,00	120	200	40	92,04	180	200	40	
PIG28B040	40	585,00	566,54	75	180	30	65,64	120	200	40	94,40	180	200	40	
PIG28B045	45	659,00	637,22	75	180	30		120	200	40		180	200	40	
PIG28B057	57	828,00	806,99	75	180	30		120	200	40		180	200	40	
RF28B038	38	560,00	538,27	100	200		37,00	160	240	45	68,00	180	240	45	108,00
RF28B045	45	659,00	637,22	100	200		44,00	160	240	45	80,50	180	240	45	
RF28B057	57	828,00	806,99	100	200		64,00	160	240	45	116,00	180	240	45	181,00
RF28B076	76	1097,00	1075,60	100	200		107,00	180	240	45	172,00	200	250	45	280,00
RF28B095	95	1366,00	1344,40	120	200		150,00	180	240	45	239,00	200	260	45	375,00
RF28B114	114	1634,00	1613,20	120	200		190,00	180	280	45	280,00	200	280	45	450,00

(1) : Préciser PIG + S : simple, D : double, T : triple + Code  
M\* : Masse

# 32B

Pignon avec moyeu déporté pour  
Chaîne Simple, Double et Triple.  
2" ~ 50,8 x 30,8 mm

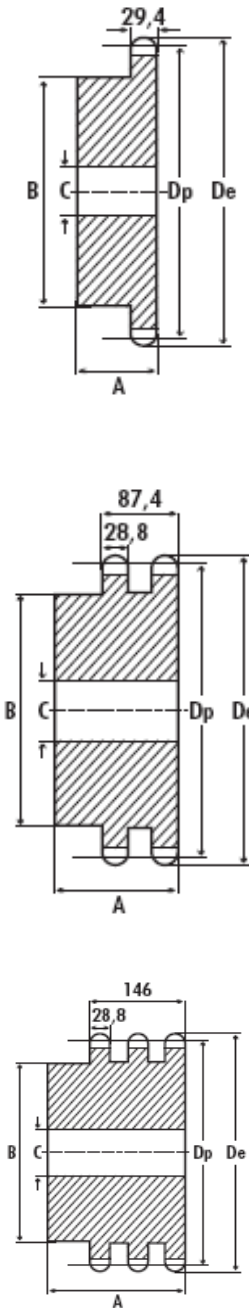

ACIER C43				Pignon Simple				Pignon Double				Pignon Triple			
REF(1)	Z	De	Dp	A	B	C	M*	A	B	C	M*	A	B	C	M*
PIG32B008	8	153,20	132,74	80	85	30	4,70	120	85	30	7,50	180	85	30	
PIG32B009	9	169,00	148,54	80	100	30	6,20	120	100	30	9,50	180	100	30	
PIG32B010	10	185,00	164,39	80	115	30	8,00	120	115	30	12,40	180	115	30	
PIG32B011	11	200,80	180,31	80	125	30	9,50	120	125	35	14,80	180	125	35	
PIG32B012	12	216,80	196,29	80	133	30	11,40	120	133	35	17,60	180	133	35	
PIG32B013	13	232,80	212,29	80	145	30	13,50	120	145	35	21,50	180	145	35	
PIG32B014	14	248,80	228,29	80	155	30	15,50	120	155	35	24,50	180	145	35	
PIG32B015	15	264,80	244,30	80	160	30	17,00	120	160	35	27,70	180	160	35	
PIG32B016	16	280,90	260,40	90	160	30	20,00	120	160	40	31,20	180	160	40	
PIG32B017	17	296,90	276,46	90	170	30	21,50	120	180	40	36,50	180	200	40	
PIG32B018	18	313,00	292,55	90	170	30	23,00	120	180	40	40,50	180	200	40	
PIG32B019	19	329,10	308,66	90	170	30	24,50	120	200	40	45,50	180	200	40	
PIG32B020	20	345,20	324,71	90	180	40	28,00	120	200	40	48,00	180	200	40	
PIG32B021	21	361,30	340,82	90	180	40	29,50	120	200	40	54,50	180	200	40	
PIG32B022	22	377,50	356,98	90	180	40	30,90	120	200	40	57,10	180	200	40	
PIG32B023	23	393,60	373,08	90	180	40	33,00	120	200	40	64,00	180	200	40	
PIG32B024	24	409,70	389,18	90	180	40	34,43	120	200	40	66,78	180	200	40	
PIG32B025	25	425,80	405,33	90	180	40	37,50	120	200	40	75,00	180	200	40	
PIG32B026	26	441,90	421,44	90	180	40	39,00	120	200	40	78,00	180	200	40	
PIG32B027	27	458,10	437,59	90	180	40	40,50	120	200	40	81,00	180	200	40	
PIG32B028	28	474,20	453,69	90	180	40	42,00	120	200	40	84,00	180	200	40	
PIG32B029	29	492,00	469,85	90	180	40	43,50	120	200	40	87,00	180	200	40	
PIG32B030	30	506,50	486,00	90	180	40	45,00	120	200	40	108,00	180	200	40	
PIG32B032	32	538,80	518,27	90	180	40	46,45	120	200	40	115,20	180	200	40	
PIG32B035	35	589,50	566,71	90	180	40	50,80	120	200	40	126,00	180	200	40	
PIG32B038	38	635,50	615,16	90	180	40	55,15	120	200	40	136,80	180	200	40	
PIG32B040	40	670,30	647,47	90	180	40	58,05	120	200	40	144,00	180	200	40	
PIG32B045	45	755,50	728,25	90	180	40		120	200	40		180	200	40	
PIG32B057	57	950,00	922,17	90	180	40		120	200	40		180	200	40	
RF32B038	38	642,50	615,17	140	200	45		180	250	45		200	260	45	
RF32B045	45	755,50	728,25	140	200	45		180	250	45		200	260	45	
RF32B057	57	950,00	922,17	140	200	45		180	250	45		200	260	45	
RF32B076	76	1257,00	1229,28	140	200	45		180	250	45		200	260	45	
RF32B095	95	1564,00	1536,44	140	200	45		180	260	45		200	260	45	
RF32B114	114	1871,00	1843,60	140	200	45		180	280	45		200	280	45	

(1) : Préciser PIG + S : simple, D : double, T : triple + Code  
M\* : Masse

# *DISQUES ACIER*

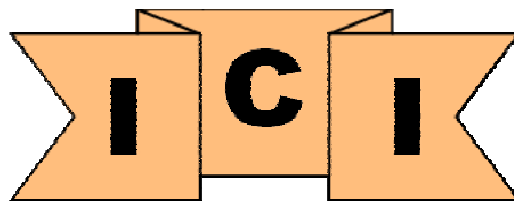

# 06B

Disque pour Chaîne  
Simple, Double et Triple.  
3/8" ~ 9,525 x 5,72 mm



ACIER C43 à C45				Simple			Double			Triple			ACIER C43 à C45				Simple			Double			Triple						
REF(1)	Z	De	Dp	D	M*	D	M*	D	M*	REF(1)	Z	De	Dp	D	M*	D	M*	D	M*	REF(1)	Z	De	Dp	D	M*	D	M*	D	M*
DIS06B008	8	28,0	24,89	6	0,01	8	0,03	8		DIS06B044	44	137,60	133,52	16	0,54	20		20		DIS06B044	44	137,60	133,52	16	0,54	20		20	
DIS06B009	9	31,0	27,85	8	0,02	8	0,04	8		DIS06B045	45	140,70	136,54	16	0,56	20	1,61	20		DIS06B045	45	140,70	136,54	16	0,56	20	1,61	20	
DIS06B010	10	34,0	30,82	8	0,02	8	0,06	10		DIS06B046	46	143,70	139,58	20	0,57	20		20		DIS06B046	46	143,70	139,58	20	0,57	20		20	
DIS06B011	11	37,0	33,80	8	0,03	10	0,07	12		DIS06B047	47	146,70	142,61	20	0,59	20		20	0,59	DIS06B047	47	146,70	142,61	20	0,59	20		20	0,59
DIS06B012	12	40,0	36,80	8	0,04	10	0,09	12		DIS06B048	48	149,70	145,64	20	0,61	20	1,80	20		DIS06B048	48	149,70	145,64	20	0,61	20	1,80	20	
DIS06B013	13	43,0	39,80	8	0,04	10	0,10	12		DIS06B049	49	152,70	148,66	20	0,65	20		20		DIS06B049	49	152,70	148,66	20	0,65	20		20	
DIS06B014	14	46,3	42,80	8	0,05	10	0,12	12		DIS06B050	50	155,70	151,69	20	0,68	20	2,00	20		DIS06B050	50	155,70	151,69	20	0,68	20	2,00	20	
DIS06B015	15	49,3	45,81	8	0,06	12	0,14	12		DIS06B051	51	158,70	154,72	20	0,71	20		20	3,40	DIS06B051	51	158,70	154,72	20	0,71	20		20	3,40
DIS06B016	16	52,3	48,82	10	0,07	12	0,16	12		DIS06B052	52	161,80	157,75	20	0,75	20		20		DIS06B052	52	161,80	157,75	20	0,75	20		20	
DIS06B017	17	55,3	51,83	10	0,08	12	0,18	12		DIS06B053	53	164,80	160,78	20	0,78	20		20		DIS06B053	53	164,80	160,78	20	0,78	20		20	
DIS06B018	18	58,3	54,85	10	0,09	12	0,20	12		DIS06B054	54	167,80	163,82	20	0,81	20		20		DIS06B054	54	167,80	163,82	20	0,81	20		20	
DIS06B019	19	61,3	57,87	10	0,10	12	0,25	12	0,10	DIS06B055	55	170,80	166,85	20	0,83	20	2,50	20		DIS06B055	55	170,80	166,85	20	0,83	20	2,50	20	
DIS06B020	20	64,3	60,89	10	0,11	12	0,27	12		DIS06B056	56	173,80	169,88	20	0,87	20		25		DIS06B056	56	173,80	169,88	20	0,87	20		25	
DIS06B021	21	68,0	63,91	12	0,12	12	0,30	16	0,12	DIS06B057	57	176,90	172,91	20	0,90	20	2,60	25	4,40	DIS06B057	57	176,90	172,91	20	0,90	20	2,60	25	4,40
DIS06B022	22	71,0	66,93	12	0,13	12	0,34	16		DIS06B058	58	179,90	175,93	20	0,93	20	2,70	25		DIS06B058	58	179,90	175,93	20	0,93	20	2,70	25	
DIS06B023	23	73,5	69,95	12	0,14	12	0,36	16		DIS06B059	59	183,00	178,96	20	0,94	20		25		DIS06B059	59	183,00	178,96	20	0,94	20		25	
DIS06B024	24	77,0	72,97	12	0,16	12	0,39	16		DIS06B060	60	186,00	181,99	20	0,98	20	2,90	25	4,79	DIS06B060	60	186,00	181,99	20	0,98	20	2,90	25	4,79
DIS06B025	25	80,0	76,00	12	0,17	12	0,43	16		DIS06B062	62	192,10	188,06	20	1,05	25		25		DIS06B062	62	192,10	188,06	20	1,05	25		25	
DIS06B026	26	83,0	79,02	12	0,18	16	0,47	16		DIS06B064	64	198,20	194,12	20	1,12	25		25	5,55	DIS06B064	64	198,20	194,12	20	1,12	25		25	5,55
DIS06B027	27	86,0	82,04	12	0,19	16	0,48	16		DIS06B065	65	201,60	197,15	20	1,16	25	3,40	25		DIS06B065	65	201,60	197,15	20	1,16	25	3,40	25	
DIS06B028	28	89,0	85,07	12	0,22	16	0,50	16		DIS06B066	66	204,60	200,18	20	1,18	25		25		DIS06B066	66	204,60	200,18	20	1,18	25		25	
DIS06B029	29	89,0	88,09	12	0,23	16	0,52	16		DIS06B068	68	210,70	206,24	20	1,30	25		25		DIS06B068	68	210,70	206,24	20	1,30	25		25	
DIS06B030	30	92,0	91,12	12	0,24	16	0,68	16		DIS06B070	70	216,70	212,30	20	1,35	25		25		DIS06B070	70	216,70	212,30	20	1,35	25		25	
DIS06B031	31	94,7	94,15	16	0,26	16	0,70	16	0,27	DIS06B072	72	222,80	218,37	20	1,45	25		25		DIS06B072	72	222,80	218,37	20	1,45	25		25	
DIS06B032	32	98,3	97,17	16	0,27	16	0,72	16		DIS06B075	75	231,90	227,46	20	1,55	25		25		DIS06B075	75	231,90	227,46	20	1,55	25		25	
DIS06B033	33	101,3	100,20	16	0,29	16	0,74	16		DIS06B076	76	234,90	230,49	20	1,60	25	4,75	25	7,85	DIS06B076	76	234,90	230,49	20	1,60	25	4,75	25	7,85
DIS06B034	34	104,3	103,23	16	0,31	16	0,77	16		DIS06B078	78	241,00	236,55	20	1,64	25		25		DIS06B078	78	241,00	236,55	20	1,64	25		25	
DIS06B035	35	107,3	106,26	16	0,34	16	1,00	16		DIS06B080	80	247,10	242,61	20	1,75	25	5,26	25	9,00	DIS06B080	80	247,10	242,61	20	1,75	25	5,26	25	9,00
DIS06B036	36	110,4	109,29	16	0,35	16	1,02	20		DIS06B085	85	262,20	257,77	25	2,00	25		25	14,4	DIS06B085	85	262,20	257,77	25	2,00	25		25	14,4
DIS06B037	37	113,4	112,32	16	0,37	16	1,05	20		DIS06B090	90	277,40	272,93	25	2,25	25	6,00	25		DIS06B090	90	277,40	272,93	25	2,25	25	6,00	25	
DIS06B038	38	119,5	115,34	16	0,39	16	1,15	20		DIS06B095	95	292,50	288,08	25	2,50	25	7,50	25		DIS06B095	95	292,50	288,08	25	2,50	25	7,50	25	
DIS06B039	39	122,5	118,37	16	0,41	16	1,18	20		DIS06B100	100	307,70	303,25	25	2,90	25	9,00	25		DIS06B100	100	307,70	303,25	25	2,90	25	9,00	25	
DIS06B040	40	125,5	121,40	16	0,43	16	1,25	20		DIS06B110	110	338,00	333,55	25	3,49	25		25		DIS06B110	110	338,00	333,55	25	3,49	25		25	
DIS06B041	41	128,5	124,43	16	0,50	20	1,28	20		DIS06B114	114	349,50	345,68	25	3,75	25	11,30	25		DIS06B114	114	349,50	345,68	25	3,75	25	11,30	25	
DIS06B042	42	131,6	127,46	16	0,50	20	1,31	20		DIS06B120	120	368,30	363,86	25	4,15	25		25		DIS06B120	120	368,30	363,86	25	4,15	25		25	
DIS06B043	43	134,6	130,49	16	0,51	20	1,34	20		DIS06B125	125	383,50	379,02	25	4,50	25	13,60	25		DIS06B125	125	383,50	379,02	25	4,50	25	13,60	25	

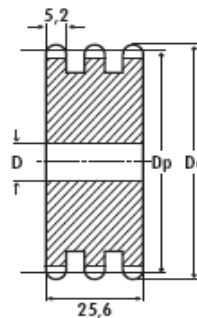
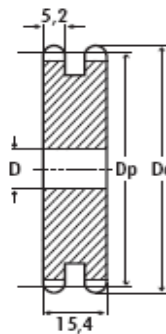
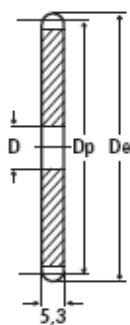

(1) : Préciser DIS + S : simple, D : double, T : triple + Code  
M\* : Masse

# 08B

Disque pour Chaîne  
Simple, Double et Triple.  
1/2" ~ 12,7 x 7,75 mm



ACIER C43 à C45				Simple			Double			Triple			ACIER C43 à C45				Simple			Double			Triple								
REF(1)	Z	De	Dp	D	M*	D	M*	D	M*	D	M*	REF(1)	Z	De	Dp	D	M*	D	M*	D	M*	D	M*	D	M*	D	M*	D	M*	D	M*
DIS08B008	8	37,20	33,18	8	0,03	10	0,08	10	0,11	DIS08B044	44	183,80	178,03	20	1,25	20	3,6	25	6,19												
DIS08B009	9	41,00	37,13	8	0,04	10	0,11	10	0,15	DIS08B045	45	188,00	182,07	20	1,30	20	3,85	25	6,45												
DIS08B010	10	45,20	41,10	8	0,06	10	0,13	10	0,20	DIS08B046	46	192,10	186,10	20	1,35	20	4,01	25	6,80												
DIS08B011	11	48,70	45,07	10	0,07	10	0,18	12	0,29	DIS08B047	47	196,20	190,14	20	1,40	20	4,25	25	7,15												
DIS08B012	12	53,00	49,07	10	0,08	10	0,18	12	0,36	DIS08B048	48	200,30	194,18	20	1,50	20	4,55	25	7,40												
DIS08B013	13	57,40	53,06	10	0,10	10	0,24	12	0,44	DIS08B049	49	204,30	198,22	20	1,55	20	4,66	25	7,55												
DIS08B014	14	61,80	57,07	10	0,12	10	0,28	12	0,54	DIS08B050	50	208,30	202,26	20	1,65	20	4,85	25	8,10												
DIS08B015	15	65,50	61,09	10	0,15	10	0,32	12	0,62	DIS08B051	51	212,10	206,30	20	1,70	25	5,01	25	8,26												
DIS08B016	16	69,50	65,10	10	0,16	12	0,39	16	0,73	DIS08B052	52	216,10	210,34	20	1,85	25	5,25	25	8,75												
DIS08B017	17	73,60	69,11	10	0,18	12	0,46	16	0,80	DIS08B053	53	220,20	214,37	20	1,90	25	5,45	25	9,10												
DIS08B018	18	77,80	73,14	10	0,20	12	0,53	16	0,90	DIS08B054	54	224,10	218,43	20	1,95	25	5,65	25	9,45												
DIS08B019	19	81,70	77,16	10	0,23	12	0,61	16	0,98	DIS08B055	55	228,10	222,46	20	2,00	25	5,85	25	9,85												
DIS08B020	20	85,80	81,19	10	0,25	12	0,67	16	1,15	DIS08B056	56	232,20	226,50	20	2,15	25	6,10	25	10,20												
DIS08B021	21	89,70	85,22	12	0,28	16	1,15	16	1,25	DIS08B057	57	236,40	230,54	20	2,20	25	6,35	25	10,60												
DIS08B022	22	93,80	89,24	12	0,31	16	0,84	16	1,41	DIS08B058	58	240,50	234,58	20	2,25	25	6,55	25	10,78												
DIS08B023	23	98,20	93,27	12	0,33	16	0,91	16	1,54	DIS08B059	59	244,50	238,62	20	2,28	25	6,66	25	10,97												
DIS08B024	24	101,80	97,29	12	0,37	16	1,01	16	1,70	DIS08B060	60	248,60	242,66	20	2,40	25	7,05	25	11,70												
DIS08B025	25	105,80	101,33	12	0,42	16	1,10	16	1,70	DIS08B062	62	256,90	250,75	25	2,55	25	7,54	25	11,70												
DIS08B026	26	110,00	105,36	16	0,44	16	1,21	16	2,05	DIS08B064	64	265,10	258,82	25	2,70	25	8,04	25	13,40												
DIS08B027	27	114,00	109,40	16	0,47	16	1,30	16	2,20	DIS08B065	65	269,00	262,86	25	2,00	25	8,35	25	13,80												
DIS08B028	28	118,00	113,42	16	0,49	16	1,40	16	2,40	DIS08B066	66	273,00	266,90	25	2,85	25	8,50	25	14,01												
DIS08B029	29	122,00	117,46	16	0,54	16	1,50	16	2,54	DIS08B068	68	281,00	274,99	25	3,05	25	8,80	25	15,21												
DIS08B030	30	126,21	121,50	16	0,58	16	1,60	16	2,74	DIS08B070	70	289,00	283,70	25	3,20	25	9,25	25	16,11												
DIS08B031	31	130,20	125,54	16	0,62	16	1,75	20	2,96	DIS08B072	72	297,20	291,16	25	3,40	25	10,20	25	17,01												
DIS08B032	32	134,30	129,56	16	0,66	16	1,85	20	3,14	DIS08B075	75	309,20	303,27	25	3,65	25	11,30	25	18,51												
DIS08B033	33	138,40	133,60	16	0,70	16	1,95	20	3,36	DIS08B076	76	313,30	307,33	25	3,95	25	11,50	25	19,20												
DIS08B034	34	142,60	137,64	16	0,76	16	2,10	20	3,54	DIS08B078	78	321,40	315,40	25	4,10	25	11,80	25	19,70												
DIS08B035	35	146,70	141,68	16	0,80	16	2,35	20	3,80	DIS08B080	80	329,40	323,48	25	4,25	25	12,80	25	21,30												
DIS08B036	36	151,00	145,72	16	0,84	20	2,35	20	3,96	DIS08B085	85	349,00	343,69	25	4,80	25	16,00		22,60												
DIS08B037	37	154,60	149,76	16	0,90	20	2,45	20	4,07	DIS08B090	90	369,90	363,90	25	5,45	25	16,20	25	25,01												
DIS08B038	38	158,60	153,80	16	0,95	20	2,70	20	4,40	DIS08B095	95	390,10	384,11	25	6,05	25	18,00	25	30,11												
DIS08B039	39	162,70	157,83	16	1,00	20	2,80	20	4,51	DIS08B100	100	410,30	404,31	25	6,75	25	19,01	25	32,00												
DIS08B040	40	166,80	161,87	16	1,05	20	2,95	20	4,95	DIS08B110	110	450,70	444,74	25	8,50	25	21,02	25	35,20												
DIS08B041	41	171,40	165,91	20	0,10	20	3,09	25	5,07	DIS08B114	114	466,90	460,90	25	8,76	25	25,00	25	41,00												
DIS08B042	42	175,40	169,95	20	1,15	20	3,25	25	5,60	DIS08B120	120	491,20	485,16	25	9,15	25	26,30	25	45,00												
DIS08B043	43	179,70	173,99	20	1,20	20	3,40	25	5,89	DIS08B125	125	511,30	505,37	25	10,60	25	30,00	25	53,01												

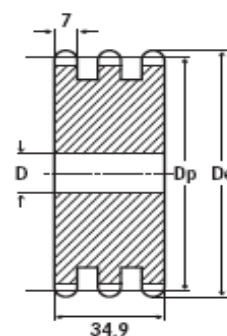
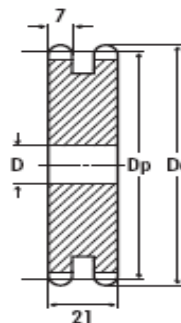
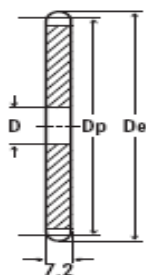

(1) : Préciser DIS + S : simple, D : double, T : triple + Code  
M\* : Masse

# 10B

Disque pour Chaîne  
Simple, Double et Triple.  
5/8" ~ 15,875 x 9,65 mm



ACIER C43 à C45				Simple		Double		Triple		ACIER C43 à C45				Simple		Double		Triple	
REF(1)	Z	De	Dp	D	M*	D	M*	D	M*	REF(1)	Z	De	Dp	D	M*	D	M*	D	M*
DIS10B008	8	47,00	41,48	10	0,07	10	0,14	12	0,20	DIS10B044	44	230,00	222,53	20	2,55	20	7,00	25	11,50
DIS10B009	9	52,60	46,42	10	0,09	10	0,19	12	0,30	DIS10B045	45	235,00	227,58	20	2,65	20	7,30	25	12,10
DIS10B010	10	57,50	51,37	10	0,12	10	0,22	12	0,45	DIS10B046	46	240,10	232,63	20	2,75	25	7,75	25	12,70
DIS10B011	11	63,00	56,34	10	0,14	12	0,30	12	0,57	DIS10B047	47	245,10	237,68	20	2,90	25	8,25	25	13,20
DIS10B012	12	68,00	61,34	10	0,17	12	0,40	12	0,72	DIS10B048	48	250,20	242,73	20	3,10	25	8,65	25	13,80
DIS10B013	13	73,00	66,32	10	0,20	12	0,50	12	0,84	DIS10B049	49	255,20	247,78	20	3,20	25	8,70	25	14,30
DIS10B014	14	78,00	71,34	12	0,24	12	0,60	12	0,98	DIS10B050	50	260,30	252,82	20	3,30	25	9,10	25	15,19
DIS10B015	15	83,00	76,36	12	0,28	12	0,70	12	1,15	DIS10B051	51	265,30	257,87	20	3,35	25	9,45	25	15,50
DIS10B016	16	88,00	81,37	12	0,31	12	0,80	16	1,30	DIS10B052	52	270,40	262,92	20	3,55	25	9,91	25	16,39
DIS10B017	17	93,00	86,39	12	0,36	12	0,90	16	1,50	DIS10B053	53	275,40	267,97	20	3,70	25	10,30	25	17,10
DIS10B018	18	98,30	91,42	12	0,39	12	1,05	16	1,80	DIS10B054	54	280,50	273,03	20	3,85	25	10,70	25	17,42
DIS10B019	19	103,30	96,45	12	0,46	12	1,20	16	1,85	DIS10B055	55	285,50	278,08	20	3,95	25	11,15	25	18,40
DIS10B020	20	108,40	101,49	12	0,50	12	1,30	16	2,10	DIS10B056	56	290,60	283,13	25	4,25	25	11,55	25	18,73
DIS10B021	21	113,40	106,52	12	0,56	16	1,50	16	2,15	DIS10B057	57	296,00	288,18	25	4,35	25	12,10	25	19,90
DIS10B022	22	118,00	111,55	12	0,60	16	1,60	16	2,65	DIS10B058	58	300,70	293,23	25	4,40	25	12,39	25	20,61
DIS10B023	23	123,40	116,58	12	0,67	16	1,80	16	2,95	DIS10B059	59	305,70	298,27	25	4,47	25	12,60	25	20,96
DIS10B024	24	128,30	121,62	12	0,73	16	2,00	16	3,24	DIS10B060	60	310,80	303,32	25	4,50	25	13,35	25	22,20
DIS10B025	25	134,00	126,66	12	0,79	16	2,15	16	3,45	DIS10B062	62	321,40	313,43	25	5,00	25	14,30	30	22,94
DIS10B026	26	139,00	131,70	16	0,87	16	2,35	20	3,75	DIS10B064	64	331,50	323,53	25	5,16	25	14,62	30	23,68
DIS10B027	27	144,00	136,75	16	0,94	16	2,60	20	4,11	DIS10B065	65	336,50	328,58	25	5,34	25	15,70	30	26,00
DIS10B028	28	148,70	141,78	16	1,01	16	2,75	20	4,45	DIS10B066	66	341,60	333,63	25	5,42	25	15,94	30	26,60
DIS10B029	29	153,80	146,83	16	1,05	16	2,95	20	4,75	DIS10B068	68	351,70	343,74	25	5,58	25	16,42	30	27,20
DIS10B030	30	158,80	151,87	16	1,16	16	3,14	20	5,10	DIS10B070	70	361,80	353,84	25	6,41	25	18,54	30	30,21
DIS10B031	31	163,90	156,92	16	1,25	20	3,45	20	5,50	DIS10B072	72	371,90	363,95	25	6,60	25	19,45	30	32,10
DIS10B032	32	168,90	161,95	16	1,35	20	3,70	20	5,91	DIS10B075	75	387,10	379,09	25	7,25	25	21,00	30	35,00
DIS10B033	33	174,50	167,00	16	1,40	20	4,00	20	6,24	DIS10B076	76	392,10	384,16	25	7,45	25	21,69	30	36,00
DIS10B034	34	179,00	172,05	16	1,50	20	4,20	20	6,65	DIS10B078	78	402,20	394,25	25	7,64	25	22,27	30	39,94
DIS10B035	35	184,10	177,10	16	1,56	20	4,49	20	7,05	DIS10B080	80	412,30	404,35	25	8,30	25	24,00	30	40,00
DIS10B036	36	189,10	182,15	20	1,70	20	4,75	25	7,56	DIS10B085	85	437,60	429,62	30	9,35	30	25,00	30	42,50
DIS10B037	37	194,20	187,20	20	1,80	20	5,00	25	8,05	DIS10B090	90	462,80	454,88	30	10,55	30	32,50	30	46,00
DIS10B038	38	199,20	192,24	20	1,90	20	5,30	25	8,55	DIS10B095	95	488,50	480,14	30	11,69	30	34,20	30	56,80
DIS10B039	39	204,20	197,29	20	1,95	20	5,51	25	9,05	DIS10B100	100	513,40	505,40	30	13,00	30	36,50	30	60,00
DIS10B040	40	209,30	202,34	20	2,10	20	5,69	25	6,51	DIS10B110	110	563,90	555,92	30	15,00	30	40,00	30	77,10
DIS10B041	41	214,80	207,39	20	2,20	20	6,05	25	10,10	DIS10B114	114	584,10	576,13	30	17,39	30	48,00	30	80,00
DIS10B042	42	219,90	212,44	20	2,30	20	6,35	25	10,50	DIS10B120	120	614,80	606,44	30	18,50	30	55,00	30	91,00
DIS10B043	43	224,90	217,49	20	2,40	20	6,65	25	11,00	DIS10B125	125	639,70	631,71	30	20,01	30	58,00	30	94,50

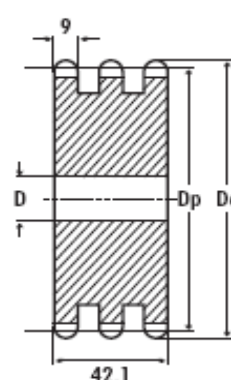
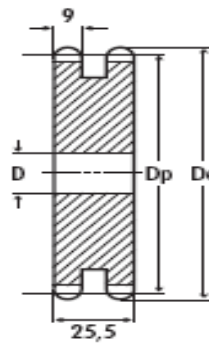
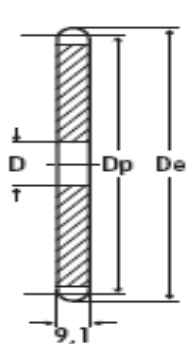

(1) : Préciser DIS + S : simple, D : double, T : triple + Code  
M\* : Masse



# 12B

Disque pour Chaîne  
Simple, Double et Triple.  
3/4" ~ 19,05 x 11,68 mm



ACIER C43 à C45				Simple		Double		Triple		ACIER C43 à C45				Simple		Double		Triple	
REF(1)	Z	De	Dp	D	M*	D	M*	D	M*	REF(1)	Z	De	Dp	D	M*	D	M*	D	M*
DIS12B008	8	57,60	49,78	12	0,13	12	0,22	12	0,30	DIS12B044	44	276,50	267,03	25	4,50	25	12,00	25	20,00
DIS12B009	9	62,00	55,70	12	0,16	12	0,33	12	0,55	DIS12B045	45	282,50	273,10	25	4,60	25	12,60	25	21,00
DIS12B010	10	69,00	61,64	12	0,20	12	0,48	12	0,75	DIS12B046	46	287,90	279,16	25	4,95	25	13,1	25	21,47
DIS12B011	11	75,00	67,61	14	0,25	14	0,62	16	1,00	DIS12B047	47	294,00	285,21	25	5,10	25	13,5	25	23,00
DIS12B012	12	81,50	73,60	14	0,30	14	0,77	16	1,30	DIS12B048	48	300,10	291,27	25	5,25	25	14,30	25	24,10
DIS12B013	13	87,50	79,59	14	0,35	14	0,90	16	1,50	DIS12B049	49	306,20	297,33	25	5,36	25	14,60	25	24,60
DIS12B014	14	93,60	85,61	14	0,41	14	1,05	16	1,75	DIS12B050	50	312,30	303,39	25	5,60	25	15,50	25	26,00
DIS12B015	15	99,80	91,63	14	0,49	14	1,20	16	2,00	DIS12B051	51	318,40	309,45	25	5,90	25	16,20	25	26,52
DIS12B016	16	105,50	97,65	14	0,55	16	1,45	16	2,35	DIS12B052	52	324,50	315,50	25	6,15	25	16,90	25	28,00
DIS12B017	17	111,50	103,67	14	0,64	16	1,75	16	2,75	DIS12B053	53	330,50	321,56	25	6,40	25	17,50	25	28,53
DIS12B018	18	118,00	109,71	14	0,70	16	2,10	16	3,10	DIS12B054	54	336,80	327,64	25	6,60	25	18,20	25	30,50
DIS12B019	19	124,20	115,75	14	0,75	16	2,35	16	3,45	DIS12B055	55	342,70	337,70	25	6,90	25	18,90	25	31,50
DIS12B020	20	129,70	121,78	14	0,85	16	2,65	16	3,70	DIS12B056	56	348,70	339,75	25	7,20	25	19,70	30	32,07
DIS12B021	21	136,00	127,82	16	0,95	16	2,85	20	4,30	DIS12B057	57	355,40	345,81	25	7,45	25	20,50	30	34,00
DIS12B022	22	141,80	133,86	16	1,05	16	3,10	20	4,75	DIS12B058	58	361,50	351,87	25	7,70	25	21,20	30	35,00
DIS12B023	23	149,00	139,90	16	1,20	16	0,30	20	5,25	DIS12B059	59	367,50	357,93	25	7,83	25	21,56	30	35,60
DIS12B024	24	153,90	145,94	16	1,25	16	3,50	20	5,60	DIS12B060	60	373,00	363,99	25	8,20	25	22,60	30	38,00
DIS12B025	25	160,00	152,00	16	1,40	16	3,75	20	6,15	DIS12B062	62	385,10	376,12	25	8,75	30	24,50	30	39,26
DIS12B026	26	165,90	158,04	16	1,55	20	4,10	20	6,70	DIS12B064	64	397,20	388,24	25	9,03	30	25,30	30	40,53
DIS12B027	27	172,30	164,09	16	1,60	20	4,40	20	7,25	DIS12B065	65	403,20	394,29	25	9,65	30	27,00	30	44,50
DIS12B028	28	178,00	170,13	16	1,75	20	4,75	20	7,80	DIS12B066	66	409,20	400,35	30	9,80	30	27,41	30	45,20
DIS12B029	29	184,10	176,19	16	1,95	20	5,10	20	8,40	DIS12B068	68	421,40	412,49	30	10,09	30	28,24	30	46,56
DIS12B030	30	190,50	182,25	16	2,10	20	5,40	20	8,95	DIS12B070	70	433,60	424,60	30	11,30	30	31,20	30	52,00
DIS12B031	31	196,30	188,31	20	2,20	20	5,80	25	9,65	DIS12B072	72	447,00	436,74	30	11,60	30	33,00	30	55,00
DIS12B032	32	203,30	194,35	20	2,30	20	6,25	25	10,20	DIS12B075	75	463,90	454,91	30	12,60	30	36,00	30	57,30
DIS12B033	33	209,30	200,40	20	2,45	20	6,65	25	11,00	DIS12B076	76	469,90	460,99	30	13,00	30	37,00	30	62,00
DIS12B034	34	214,60	206,46	20	2,60	20	7,10	25	11,70	DIS12B078	78	482,10	473,10	30	13,34	30	38,00	30	63,63
DIS12B035	35	221,00	212,52	20	2,75	20	7,45	25	12,31	DIS12B080	80	494,20	485,22	30	14,40	30	41,00	30	68,50
DIS12B036	36	226,80	218,58	20	2,90	25	7,90	25	13,20	DIS12B085	85	524,50	515,55	30	16,40	30	44,00	30	73,00
DIS12B037	37	232,90	224,64	20	3,25	25	8,40	25	14,00	DIS12B090	90	554,80	545,86	30	18,30	30	54,00	30	92,00
DIS12B038	38	239,00	230,69	20	3,30	25	8,85	25	14,79	DIS12B095	95	585,10	576,17	30	20,40	30	58,00	30	97,50
DIS12B039	39	245,10	236,75	20	3,45	25	9,35	25	15,70	DIS12B100	100	615,40	606,47	30	22,50	30	62,00	30	105,00
DIS12B040	40	251,30	242,81	20	3,45	25	9,60	25	16,70	DIS12B110	110	676,10	667,11	30	24,80	30	79,00	30	130,00
DIS12B041	41	257,30	248,87	25	3,85	25	10,40	25	17,11	DIS12B114	114	700,60	691,36	30	30,00	30	82,00	30	136,00
DIS12B042	42	264,50	254,93	25	4,00	25	10,80	25	18,20	DIS12B120	120	736,70	727,74	30	33,60	30	94,00	30	157,00
DIS12B043	43	270,50	260,98	25	4,25	25	11,30	25	19,10	DIS12B125	125	767,00	758,05	30	35,00	30	98,00	30	164,00

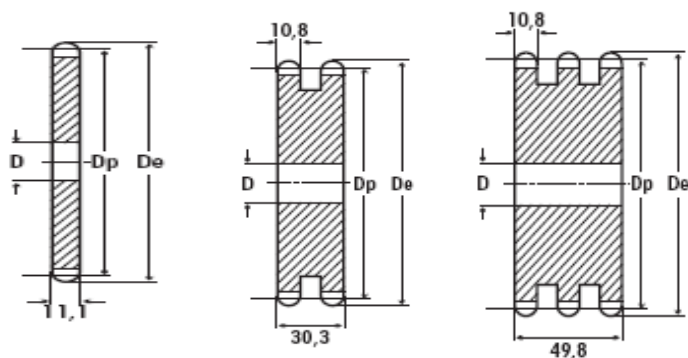

(1) : Préciser DIS + S : simple, D : double, T : triple + Code  
M\* : Masse

# 16B

Disque pour Chaîne  
Simple, Double et Triple.  
1" ~ 25,4 x 17,02 mm



ACIER C43 à C45

Simple Double Triple

ACIER C43 à C45

Simple Double Triple

REF(1)	Z	De	Dp	D	M*	D	M*	D	M*	REF(1)	Z	De	Dp	D	M*	D	M*	D	M*
DIS16B008	8	77,00	66,37	12	0,30	16	0,50	20	0,85	DIS16B044	44	369,10	356,06	25	11,20	25	33,10	30	56,00
DIS16B009	9	85,00	74,27	12	0,40	16	0,85	20	1,55	DIS16B045	45	377,10	364,12	25	11,70	25	35,00	30	58,00
DIS16B010	10	93,00	82,19	12	0,50	16	1,35	20	2,10	DIS16B046	46	385,20	372,21	25	12,30	30	37,00	30	61,50
DIS16B011	11	99,50	90,14	16	0,60	20	1,55	20	2,85	DIS16B047	47	393,20	380,29	25	12,57	30	37,80	30	62,83
DIS16B012	12	109,00	98,14	16	0,80	20	1,95	20	3,35	DIS16B048	48	401,30	388,36	25	13,20	30	41,50	30	67,00
DIS16B013	13	117,00	106,12	16	0,90	20	2,50	20	4,15	DIS16B049	49	409,30	396,44	25	13,47	30	42,36	30	68,40
DIS16B014	14	125,00	114,15	16	1,05	20	2,85	20	4,75	DIS16B050	50	417,40	404,52	25	14,50	30	43,50	30	73,50
DIS16B015	15	133,00	122,17	16	1,25	20	3,25	20	5,50	DIS16B051	51	425,50	412,60	30	14,80	30	44,37	40	74,98
DIS16B016	16	141,00	130,20	20	1,40	20	3,75	30	6,35	DIS16B052	52	433,60	420,67	30	15,70	30	47,00	40	79,50
DIS16B017	17	149,00	138,22	20	1,55	20	4,25	30	7,40	DIS16B053	53	441,70	428,75	30	16,00	30	48,00	40	81,00
DIS16B018	18	157,00	146,28	20	1,85	20	5,00	30	8,50	DIS16B054	54	448,30	436,85	30	16,30	30	48,80	40	82,55
DIS16B019	19	165,20	154,33	20	2,10	20	5,60	30	9,25	DIS16B055	55	457,90	444,93	30	18,70	30	53,00	40	89,00
DIS16B020	20	173,20	162,38	20	2,30	20	6,40	30	10,40	DIS16B056	56	466,00	453,01	30	18,20	40	55,00	40	90,62
DIS16B021	21	181,20	170,43	20	2,50	25	7,25	30	11,50	DIS16B057	57	474,00	461,07	30	18,70	40	57,00	40	96,00
DIS16B022	22	189,30	178,48	20	2,75	25	7,85	30	13,00	DIS16B058	58	482,10	469,16	30	19,02	40	58,00	40	97,68
DIS16B023	23	197,50	186,53	20	3,10	25	8,75	30	14,50	DIS16B059	59	490,20	477,24	30	19,35	40	59,00	40	99,37
DIS16B024	24	205,50	194,59	20	3,25	25	9,45	30	15,49	DIS16B060	60	498,30	485,32	30	20,80	40	63,00	40	106,00
DIS16B025	25	213,50	202,66	20	3,45	25	10,20	30	17,00	DIS16B062	62	514,50	501,50	30	22,30	40	68,00	40	109,53
DIS16B026	26	221,60	210,72	20	3,90	25	11,30	30	18,50	DIS16B064	64	530,70	517,65	30	23,02	40	70,20	40	113,06
DIS16B027	27	229,60	218,79	20	4,15	25	12,00	30	20,00	DIS16B065	65	538,80	525,73	30	24,30	40	75,00	40	125,00
DIS16B028	28	237,70	226,85	20	4,45	25	13,10	30	22,00	DIS16B066	66	546,80	533,80	30	24,67	40	76,15	40	127,00
DIS16B029	29	245,80	234,92	20	4,90	25	13,90	30	23,50	DIS16B068	68	562,90	549,98	30	27,10	40	82,50	40	138,00
DIS16B030	30	254,00	243,00	20	5,15	25	14,90	30	24,50	DIS16B070	70	579,20	566,14	30	28,50	40	87,50	40	146,00
DIS16B031	31	262,00	251,08	25	5,50	25	15,90	30	27,00	DIS16B072	72	595,40	582,32	30	29,70	40	90,50	40	150,00
DIS16B032	32	270,00	259,13	25	5,90	25	16,90	30	29,00	DIS16B075	75	619,70	606,55	30	32,50	40	100,00	40	156,25
DIS16B033	33	278,50	267,21	25	6,25	25	18,20	30	30,50	DIS16B076	76	627,00	614,65	30	33,20	40	105,00	40	173,00
DIS16B034	34	287,00	275,28	25	6,75	25	19,30	30	32,50	DIS16B078	78	643,30	630,80	30	34,07	40	107,76	40	177,50
DIS16B035	35	296,20	283,36	25	7,10	25	20,40	30	34,50	DIS16B080	80	660,00	646,96	30	37,40	40	115,00	40	190,00
DIS16B036	36	304,60	291,44	25	7,45	25	22,00	30	35,48	DIS16B085	85	699,90	687,40	30	40,50	40	122,50	40	202,00
DIS16B037	37	312,60	299,51	25	7,75	25	23,10	30	36,46	DIS16B090	90	740,30	727,81	30	49,00	40	155,00	40	255,00
DIS16B038	38	320,70	307,59	25	8,25	25	24,50	30	41,00	DIS16B095	95	781,10	768,22	30	53,00	40	164,00	40	270,00
DIS16B039	39	328,80	315,67	25	8,80	25	25,70	30	42,10	DIS16B100	100	821,10	808,63	30	56,00	40	173,00	40	284,00
DIS16B040	40	336,90	323,73	25	9,40	25	27,20	30	45,50	DIS16B110	110	902,00	889,48	30	72,00	40	220,00	40	370,00
DIS16B041	41	345,00	331,82	25	9,64	25	27,88	30	46,63	DIS16B114	114	934,30	921,81	30	75,00	40	228,00	40	386,00
DIS16B042	42	353,00	339,90	25	10,10	25	30,10	30	51,00	DIS16B120	120	982,80	970,33	30	86,00	40	250,00	40	425,00
DIS16B043	43	361,10	347,98	25	11,00	25	31,90	30	52,21	DIS16B125	125	1023,20	1010,73	30	90,00	40	280,00	40	465,00

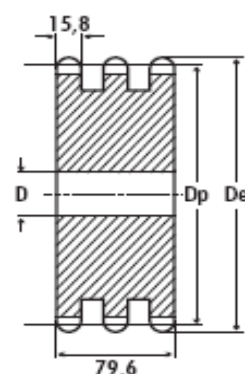
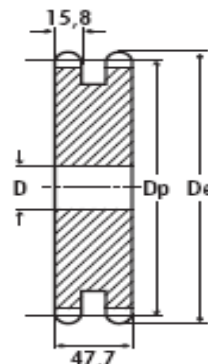
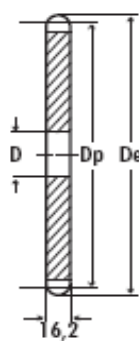

(1) : Préciser DIS + S : simple, D : double, T : triple + Code  
M\* : Masse

# 20B

Disque pour Chaîne  
Simple, Double et Triple.  
1" 1/4 ~ 31,75 x 19,56 mm



ACIER C43 à C45									ACIER C43 à C45										
			Simple		Double		Triple					Simple		Double		Triple			
REF(1)	Z	De	Dp	D	M*	D	M*	D	M*	REF(1)	Z	De	Dp	D	M*	D	M*	D	M*
DIS20B008	8	98,10	82,96	16	0,50	20	1,40	20	2,20	DIS20B042	42	440,00	424,88	30	19,00	30	58,50	40	102,66
DIS20B009	9	108,00	92,84	16	0,75	20	2,25	20	3,40	DIS20B043	43	450,10	434,97	30	19,45	30	60,00	40	105,11
DIS20B010	10	117,90	102,74	16	1,10	20	3,00	20	3,70	DIS20B044	44	460,20	445,07	30	19,80	30	61,30	40	107,55
DIS20B011	11	127,80	112,68	20	1,25	20	3,75	25	6,00	DIS20B045	45	470,30	455,17	30	22,00	30	67,00	40	110,00
DIS20B012	12	137,80	122,68	20	1,45	20	4,50	25	7,50	DIS20B046	46	480,40	465,26	30	23,00	30	70,00	40	112,44
DIS20B013	13	147,80	132,65	20	1,70	20	5,25	25	8,70	DIS20B047	47	490,50	475,36	30	23,50	30	71,52	40	115,00
DIS20B014	14	157,80	142,68	20	2,10	20	6,10	25	10,00	DIS20B048	48	500,60	485,46	30	25,00	30	76,50	40	117,33
DIS20B015	15	167,90	152,72	20	2,45	20	7,00	25	11,50	DIS20B049	49	510,70	495,55	30	25,57	30	78,10	40	119,36
DIS20B016	16	177,90	162,75	20	2,70	30	8,10	30	13,30	DIS20B050	50	520,80	505,65	30	27,00	30	83,00	40	136,00
DIS20B017	17	187,90	172,78	20	3,00	30	9,10	30	15,00	DIS20B051	51	530,90	515,75	30	27,54	30	84,67	40	138,72
DIS20B018	18	198,00	182,85	20	3,40	30	10,40	30	17,00	DIS20B052	52	541,00	525,84	30	29,50	40	90,00	40	141,44
DIS20B019	19	208,10	192,91	20	3,60	30	11,40	30	19,00	DIS20B053	53	551,10	535,94	30	30,06	40	91,74	40	144,16
DIS20B020	20	218,10	202,98	20	4,10	30	12,70	30	21,00	DIS20B054	54	561,20	546,07	30	30,63	40	93,46	40	146,88
DIS20B021	21	228,20	213,04	25	4,50	30	13,20	30	23,50	DIS20B055	55	571,30	556,16	30	33,00	40	95,20	40	149,60
DIS20B022	22	238,30	223,11	25	5,00	30	14,50	30	26,00	DIS20B056	56	581,40	566,26	30	33,60	40	96,90	40	152,32
DIS20B023	23	248,30	233,17	25	5,50	30	16,00	30	28,30	DIS20B057	57	591,50	576,36	30	33,50	40	107,00	40	178,00
DIS20B024	24	258,40	243,23	25	6,15	30	17,50	30	31,00	DIS20B058	58	601,60	586,45	30	34,20	40	108,87	40	181,12
DIS20B025	25	268,50	253,33	25	6,60	30	20,00	30	33,00	DIS20B059	59	611,70	596,55	30	34,80	40	110,75	40	184,24
DIS20B026	26	278,60	263,40	30	7,15	30	22,00	30	36,00	DIS20B060	60	621,80	606,65	30	39,00	40	119,00	40	197,00
DIS20B027	27	288,60	273,48	30	7,75	30	23,60	30	39,00	DIS20B062	62	642,00	626,87	30	40,30	40	123,00	40	203,56
DIS20B028	28	298,70	283,56	30	8,35	30	25,50	30	42,00	DIS20B064	64	662,20	647,06	30	41,60	40	127,00	40	211,00
DIS20B029	29	308,80	293,65	30	9,10	30	27,20	30	43,50	DIS20B065	65	672,30	657,16	30	45,00	40	140,00	40	232,00
DIS20B030	30	318,90	303,75	30	9,50	30	29,00	30	48,00	DIS20B066	66	682,40	667,26	30	45,70	40	142,15	40	235,56
DIS20B031	31	329,00	313,85	30	10,20	30	31,10	30	49,60	DIS20B068	68	702,60	687,48	30	47,10	40	146,46	40	242,70
DIS20B032	32	339,10	323,91	30	11,10	30	33,50	30	55,00	DIS20B070	70	722,80	707,67	30	54,00	40	165,00	40	270,00
DIS20B033	33	349,20	334,01	30	11,80	30	34,55	30	56,71	DIS20B072	72	743,10	727,90	30	55,54	40	169,72	40	277,71
DIS20B034	34	359,30	334,10	30	12,50	30	38,10	30	63,00	DIS20B075	75	773,30	758,19	30	57,85	40	176,80	40	289,30
DIS20B035	35	369,40	354,20	30	13,50	30	40,10	30	66,50	DIS20B076	76	783,50	768,32	30	63,00	40	190,00	40	320,00
DIS20B036	36	379,50	364,30	30	14,00	30	42,60	30	71,00	DIS20B080	80	823,90	808,72	30	70,00	40	210,00	40	350,00
DIS20B037	37	389,50	374,39	30	15,00	30	43,78	30	72,98	DIS20B085	85	874,40	859,25	30	74,38	40	223,13	40	371,87
DIS20B038	38	399,60	384,49	30	15,50	30	47,50	30	79,00	DIS20B090	90	924,90	909,76	30	94,00	40	235,52	40	418,35
DIS20B039	39	409,70	394,59	30	15,90	30	48,75	30	81,07	DIS20B095	95	975,20	960,28	30	100,00	40	300,00	40	500,00
DIS20B040	40	419,80	404,66	30	17,50	30	52,50	30	88,00	DIS20B100	100	1026,00	1010,79	40	105,26	40	315,80	40	526,31
DIS20B041	41	429,90	414,78	30	17,94	30	53,81	30	90,20	DIS20B114	114	1167,40	1152,26	40	142,00	40	428,00	40	700,00

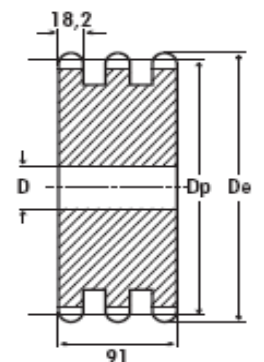
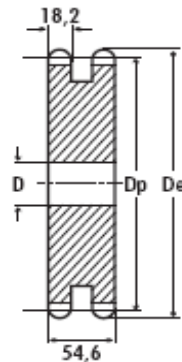
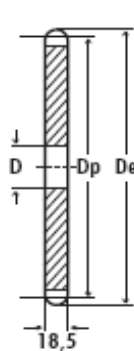

(1) : Préciser DIS + S : simple, D : double, T : triple + Code  
M\* : Masse

# 24B

Disque pour Chaîne  
Simple, Double et Triple.  
1" 1/2 ~ 38,1 x 25,4 mm



ACIER C43 à C45

Simple Double Triple

ACIER C43 à C45

Simple Double Triple

REF(1)	Z	De	Dp	D	M*	D	M*	D	M*	REF(1)	Z	De	Dp	D	M*	D	M*	D	M*
DIS24B008	8	115,00	99,55	20	1,15	25	2,40	25	4,00	DIS24B041	41	512,60	497,74	30	33,68	40		40	
DIS24B009	9	126,40	111,40	20	1,35	25	3,30	25	5,50	DIS24B042	42	524,70	509,85	30	34,50	40	103,00	40	
DIS24B010	10	138,00	123,29	20	1,60	25	4,20	25	7,20	DIS24B043	43	536,80	521,97	30	36,00	40		40	
DIS24B011	11	150,00	135,21	25	2,10	25	5,30	30	8,80	DIS24B044	44	549,00	534,08	30	36,84	40		40	
DIS24B012	12	162,00	147,22	25	2,50	25	6,60	30	11,20	DIS24B045	45	561,20	546,20	30	39,00	40	118,00	40	222,00
DIS24B013	13	174,20	159,18	25	3,00	25	8,00	30	13,60	DIS24B046	46	573,30	558,32	30	40,50	40	124,00	40	
DIS24B014	14	186,20	171,22	25	3,50	25	9,50	30	16,00	DIS24B047	47	585,40	570,43	30	41,38	40		40	
DIS24B015	15	198,20	183,26	25	4,00	25	11,00	30	18,00	DIS24B048	48	597,40	582,55	30	45,50	40	136,00	40	248,00
DIS24B016	16	210,30	195,30	25	4,60	30	13,00	30	21,50	DIS24B049	49	609,50	594,66	30	46,44	40		40	
DIS24B017	17	222,30	207,34	25	5,20	30	15,00	30	24,50	DIS24B050	50	621,70	606,78	30	50,50	40	148,00	40	
DIS24B018	18	234,30	219,42	25	6,00	30	17,00	30	27,80	DIS24B051	51	633,80	618,89	30	51,51	40		40	
DIS24B019	19	246,50	231,49	25	6,70	30	19,00	30	31,00	DIS24B052	52	646,00	631,01	30	54,00	40		40	
DIS24B020	20	258,60	243,57	25	7,50	30	21,50	30	35,00	DIS24B053	53	658,00	643,13	30	55,10	40		40	
DIS24B021	21	270,60	255,65	30	8,30	30	24,00	40	40,00	DIS24B054	54	670,20	655,25	30	56,08	40		40	
DIS24B022	22	282,70	267,73	30	9,20	30	26,50	40	44,00	DIS24B055	55	682,30	667,40	30	60,00	40		40	327,00
DIS24B023	23	294,80	279,80	30	10,20	30	29,00	40	48,00	DIS24B056	56	694,40	679,50	30	61,10	40		40	
DIS24B024	24	306,80	291,88	30	11,10	30	31,00	40	52,00	DIS24B057	57	706,50	691,73	30	65,00	40	195,00	40	365,00
DIS24B025	25	319,00	304,00	30	12,00	30	33,50	40	57,00	DIS24B058	58	718,60	703,74	30	66,14	40		40	
DIS24B026	26	331,00	316,08	30	13,10	30	37,00	40	62,00	DIS24B059	59	730,70	715,86	30	67,30	40		40	
DIS24B027	27	343,20	328,19	30	14,20	30	40,50	40	68,00	DIS24B060	60	742,80	727,97	30	72,00	40	217,00	40	
DIS24B028	28	355,20	340,27	30	15,20	30	43,50	40	72,00	DIS24B062	62	767,20	752,24	40	74,40	40		40	
DIS24B029	29	367,30	352,38	30	16,40	30	47,00	40	74,57	DIS24B064	64	791,30	776,48	40	76,80	40		40	
DIS24B030	30	379,50	364,50	30	17,50	30	50,00	40	84,00	DIS24B065	65	803,40	788,59	40	85,00	40	256,00	40	
DIS24B031	31	391,60	376,62	30	19,00	40	54,00	40	86,80	DIS24B066	66	815,60	800,17	40	86,30	40		40	
DIS24B032	32	403,70	388,69	30	20,30	40	58,00	40	97,00	DIS24B068	68	839,80	824,98	40	88,92	40		40	
DIS24B033	33	415,80	400,81	30	21,60	40	62,00	40	100,03	DIS24B070	70	864,20	849,21	40	98,00	40		40	
DIS24B034	34	427,80	412,93	30	23,00	40	66,00	40	116,00	DIS24B072	72	88,40	873,48	40	100,80	40		40	
DIS24B035	35	440,00	425,04	30	24,50	40	70,00	40	119,41	DIS24B075	75	924,80	909,83	40	105,00	40		40	
DIS24B036	36	452,00	437,16	30	26,00	40	74,00	40	122,82	DIS24B076	76	936,90	921,98	40	115,00	40	350,00	40	590,00
DIS24B037	37	464,20	449,27	30	27,00	40	79,00	40	140,00	DIS24B080	80	985,40	970,44	40	130,00	40		40	
DIS24B038	38	476,20	461,39	30	28,50	40	83,50	40	156,00	DIS24B085	85	1046,00	1031,10	40	138,12	40		40	
DIS24B039	39	488,50	473,50	30	29,25	40	85,70	40	160,10	DIS24B095	95	1167,30	1152,33	40	180,00	40		40	
DIS24B040	40	500,60	485,62	30	31,50	40	92,50	40	164,21										

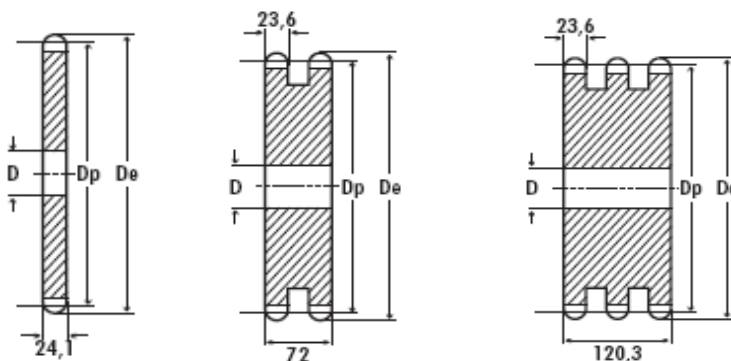

(1) : Préciser DIS + S : simple, D : double, T : triple + Code  
M\* : Masse

# 28B

Disque pour Chaîne  
Simple, Double et Triple.  
1" 3/4 ~ 44,45 x 30,99 mm



ACIER C43 à C45

Simple

Double

Triple

REF(1)	Z	De	Dp	D	M*	D	M*	D	M*
DIS28B008	8	132,00	116,15	25	1,80	25	4,40	30	7,00
DIS28B009	9	148,40	129,96	25	2,30	25	5,70	30	9,10
DIS28B010	10	162,30	143,85	25	3,00	25	7,50	30	12,00
DIS28B011	11	176,30	157,77	25	3,60	30	9,00	30	14,40
DIS28B012	12	189,50	171,74	25	4,30	30	10,80	30	17,30
DIS28B013	13	204,20	185,75	25	5,00	30	12,70	30	20,40
DIS28B014	14	218,20	199,76	25	6,00	30	15,20	30	24,40
DIS28B015	15	232,30	213,79	25	7,00	30	17,80	30	28,60
DIS28B016	16	246,30	227,84	30	8,00	30	20,50	30	33,00
DIS28B017	17	260,00	241,90	30	9,00	30	23,00	30	36,50
DIS28B018	18	274,00	255,98	30	10,00	30	26,00	30	42,00
DIS28B019	19	289,00	270,06	30	11,50	30	29,70	30	48,00
DIS28B020	20	303,00	284,15	30	13,00	30	33,50	30	54,00
DIS28B021	21	317,00	298,24	30	14,00	30	36,50	40	59,00
DIS28B022	22	331,00	312,34	30	15,50	30	40,50	40	61,80
DIS28B023	23	345,00	326,44	30	17,00	30	44,50	40	72,00
DIS28B024	24	359,00	340,55	30	18,00	30	48,00	40	75,13
DIS28B025	25	373,00	354,66	30	20,00	30	53,00	40	86,00
DIS28B026	26	387,00	368,77	30	22,00	40	58,00	40	
DIS28B027	27	401,00	382,88	30	24,00	40	60,23	40	
DIS28B028	28	416,00	397,00	30	26,00	40	69,00	40	
DIS28B029	29	430,00	411,12	30	26,93	40	71,46	40	
DIS28B030	30	444,00	425,24	30	30,00	40	80,00	40	
DIS28B031	31	439,37	458,00	30	31,00	40	82,66	40	
DIS28B032	32	472,00	453,49	30	38,50	40	85,33	40	
DIS28B033	33	486,00	467,62	30	39,70	40	88,00	40	
DIS28B034	34	500,00	481,75	30	40,80	40	90,66	40	
DIS28B035	35	514,00	495,88	30	42,00	40	112,00	40	
DIS28B036	36	529,00	510,01	30	47,50	40	115,20	40	
DIS28B037	37	543,00	524,13	30	48,82	40	118,40	40	
DIS28B038	38	557,00	538,27	30	50,00	40	135,00	40	220,00
DIS28B039	39	571,00	552,40	30	51,31	40	138,55	40	225,80
DIS28B040	40	585,00	566,54	30	55,00	40	150,00	40	245,00
DIS28B045	45	659,00	637,22	30	72,00	40	196,00	40	275,62
DIS28B050	50	726,00	707,91	30	90,00	40	248,00	40	314,21
DIS28B057	57	828,00	806,99	40	120,00	40	330,00	40	540,00
DIS28B060	60	869,00	849,32	40	130,00	40	370,00	40	568,42
DIS28B076	76	1097,00	1075,60	40	210,00	40	600,00	40	990,00

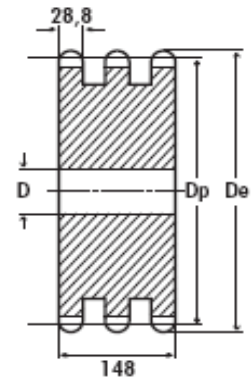
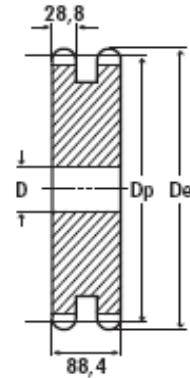
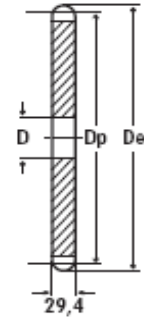

(1) : Préciser DIS + S : simple, D : double, T : triple + Code  
M\* : Masse

Page 21

# 32B

Disque pour Chaîne  
Simple, Double et Triple.  
2" ~ 50,8 x 30,8 mm



ACIER C43 à C45				Simple		Double		Triple	
REF(1)	Z	De	Dp	D	M*	D	M*	D	M*
DIS32B008	8	153,20	132,74	25	2,50	25	6,00	25	9,50
DIS32B009	9	169,00	148,54	25	3,20	25	7,70	25	12,20
DIS32B010	10	185,00	164,39	25	4,00	25	9,70	25	15,40
DIS32B011	11	200,80	180,31	30	4,80	35	11,50	35	18,50
DIS32B012	12	216,80	196,29	30	5,80	35	14,00	35	22,00
DIS32B013	13	232,80	212,29	30	7,00	35	17,00	35	27,00
DIS32B014	14	248,80	228,29	30	8,00	35	19,50	35	31,00
DIS32B015	15	264,80	244,30	30	9,00	35	22,30	35	35,50
DIS32B016	16	280,90	260,40	30	10,50	40	25,50	40	41,00
DIS32B017	17	296,90	276,46	30	12,00	40	29,50	40	47,00
DIS32B018	18	313,00	292,55	30	13,50	40	33,50	40	54,00
DIS32B019	19	329,10	308,66	30	15,00	40	37,00	40	59,00
DIS32B020	20	345,20	324,71	30	17,00	40	42,00	40	67,00
DIS32B021	21	361,30	340,82	40	18,50	40	46,00	40	74,00
DIS32B022	22	377,50	356,98	40	20,00	40	50,00	40	77,57
DIS32B023	23	393,60	373,08	40	22,00	40	55,00	40	89,00
DIS32B024	24	409,70	389,18	40	24,00	40	60,00	40	92,87
DIS32B025	25	425,80	405,33	40	26,50	40	67,00	40	107,00
DIS32B026	26	441,90	421,44	40	29,00	40	73,50	40	111,30
DIS32B027	27	458,10	437,59	40	30,12	40	76,33	40	115,56
DIS32B028	28	474,20	453,69	40	33,00	40	84,00	40	119,84
DIS32B029	29	492,00	469,85	40	34,18	40	87,00	40	124,12
DIS32B030	30	506,50	486,00	40	39,00	40	99,00	40	238,00
DIS32B032	32	538,80	518,27	40	43,00	40	105,60	40	253,86
DIS32B035	35	589,50	566,71	40	52,00	40	135,00	40	245,00
DIS32B038	38	635,50	615,16	40	65,00	40	167,00	40	269,00
DIS32B040	40	670,30	647,47	40	68,42	40	175,80	40	283,16
DIS32B045	45	755,50	728,25	40	93,50	40	240,00	40	420,00
DIS32B050	50	831,80	809,04	40	116,00	40	309,00	40	433,00
DIS32B057	57	950,00	922,17	40	150,00	40	400,00	40	650,00
DIS32B060	60	993,40	970,65	40	168,00	40	450,00	40	780,00
DIS32B076	76	1257,00	1229,28	40	270,00	40	740,00	40	1200,00

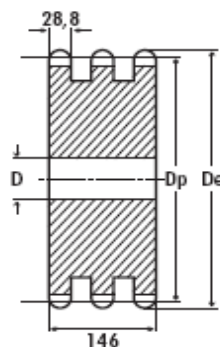
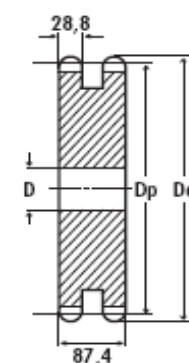
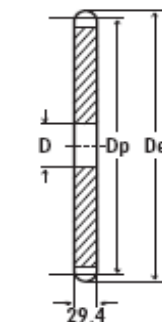

(1) : Préciser DIS + S : simple, D : double, T : triple + Code  
M\* : Masse

Page 22

# *ENGRENAGES A DENTURE DROITE*

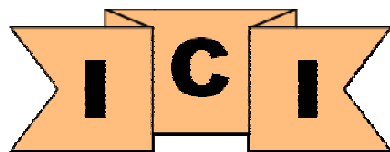
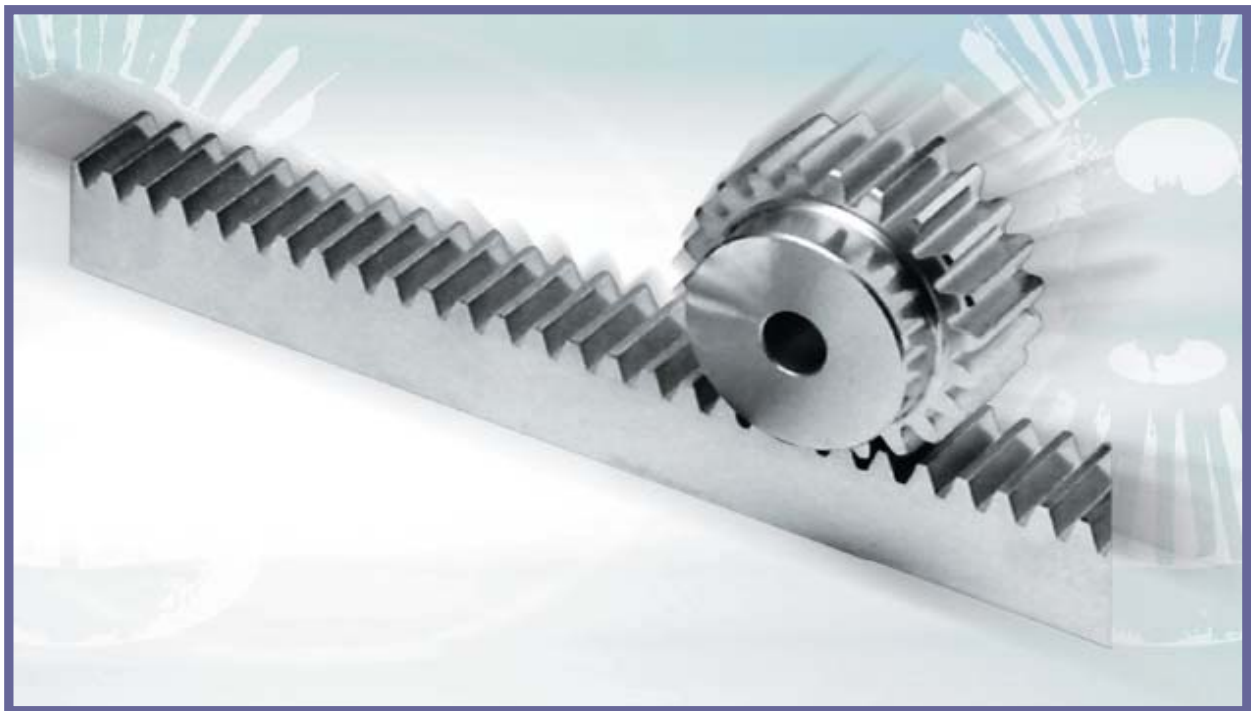

# Engrenages à Denture Droite

REF(1)	z	Mod. 1				Mod. 1,5				Mod. 2				Mod. 2,5			
		De	Dp	dm	D1	De	Dp	dm	D1	De	Dp	dm	D1	De	Dp	dm	D1
EngMod../12	12	14	12	9	6	21,0	18,0	14	8	28	24	18	10	35,0	30,0	22	10
EngMod../13	13	15	13	10	6	22,5	19,5	15	8	30	26	20	10	37,5	32,5	25	10
EngMod../14	14	16	14	11	6	24,0	21,0	17	8	32	28	22	10	40,0	35,0	28	10
EngMod../15	15	17	15	12	6	25,5	22,5	18	8	34	30	24	10	42,5	37,5	30	10
EngMod../16	16	18	16	13	6	27,0	24,0	19	8	36	32	25	10	45,0	40,0	32	12
EngMod../17	17	19	17	14	6	28,5	25,5	20	8	38	34	25	10	47,5	42,5	35	12
EngMod../18	18	20	18	15	8	30,0	27,0	20	8	40	36	25	10	50,0	45,0	35	12
EngMod../19	19	21	19	15	8	31,5	28,5	20	8	42	38	25	12	52,5	47,5	35	12
EngMod../20	20	22	20	16	8	33,0	30,0	25	8	44	40	30	12	55,0	50,0	40	12
EngMod../21	21	23	21	16	8	34,5	31,5	25	10	46	42	30	12	57,5	52,5	40	14
EngMod../22	22	24	22	18	8	36,0	33,0	25	10	48	44	30	12	60,0	55,0	45	14
EngMod../23	23	25	23	20	10	37,5	34,5	25	10	50	46	30	12	62,5	57,5	45	14
EngMod../24	24	26	24	20	10	39,0	36,0	25	10	52	48	35	12	65,0	60,0	45	14
EngMod../25	25	27	25	20	10	40,5	37,5	25	10	54	50	35	12	67,5	62,5	50	14
EngMod../26	26	28	26	20	10	42,0	39,0	30	12	56	52	40	12	70,0	65,0	50	14
EngMod../27	27	29	27	20	10	43,5	40,5	30	12	58	54	40	12	72,5	67,5	50	14
EngMod../28	28	30	28	20	10	45,0	42,0	30	12	60	56	40	12	75,0	70,0	50	14
EngMod../29	29	31	29	20	10	46,5	43,5	30	12	62	58	40	14	77,5	72,5	50	14
EngMod../30	30	32	30	20	10	48,0	45,0	30	12	64	60	40	14	80,0	75,0	55	14
EngMod../31	31	33	31	25	10	49,5	46,5	35	12	66	62	45	14	82,5	77,5	55	
EngMod../32	32	34	32	25	10	51,0	48,0	35	12	68	64	45	14	85,0	80,0	55	16
EngMod../33	33	35	33	25	10	52,5	49,5	35	12	70	66	45	14	87,5	82,5	55	16
EngMod../34	34	36	34	25	10	54,0	51,0	35	12	72	68	45	14	90,0	85,0	55	16
EngMod../35	35	37	35	25	10	55,5	52,5	35	12	74	70	45	14	92,5	87,5	60	16
EngMod../36	36	38	36	25	10	57,0	54,0	35	12	76	72	45	14	95,0	90,0	60	16
EngMod../37	37	39	37	25	10	58,5	55,5	40	12	78	74	50	14	97,5	92,5	60	16
EngMod../38	38	40	38	25	10	60,0	57,0	40	12	80	76	50	14	100,0	95,0	60	16
EngMod../39	39	41	39	25	10	61,5	58,5	40	12	82	78	50	14	102,5	97,5	60	16
EngMod../40	40	42	40	25	10	63,0	60,0	40	12	84	80	50	14	105,0	100,0	70	16
EngMod../41	41	43	41	30	10	64,5	61,5	40	12	86	82	55	16	107,5	102,5	70	16
EngMod../42	42	44	42	30	10	66,0	63,0	50	12	88	84	55	16	110,0	105,0	70	16
EngMod../43	43	45	43	30	10	67,5	64,5	50	12	90	86	55	16	112,5	107,5	70	16
EngMod../44	44	46	44	30	10	69,0	66,0	50	12	92	88	60	16	115,0	110,0	70	16
EngMod../45	45	47	45	30	10	70,5	67,5	50	12	94	90	60	16	117,5	112,5	70	16
EngMod../46	46	48	46	30	10	72,0	69,0	50	14	96	92	60	16	120,0	115,0	70	20
EngMod../47	47	49	47	30	10	73,5	70,5	50	14	98	94	70	16	122,5	117,5	70	20
EngMod../48	48	50	48	30	10	75,0	72,0	50	14	100	96	70	16	125,0	120,0	70	20
EngMod../49	49	51	49	30	10	76,5	73,5	50	14	102	98	70	16	127,5	122,5	70	20

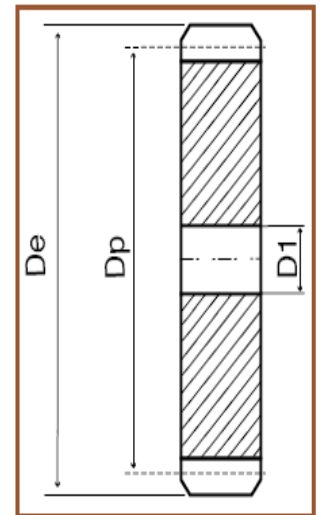
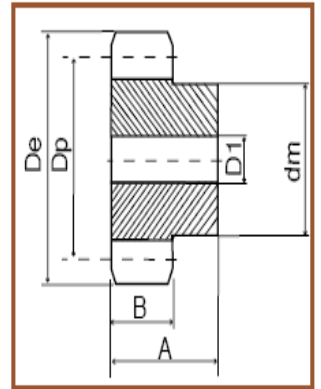

## Côte A

Module 1	= 25 mm
Module 1,5	= 30 mm
Module 2	= 35 mm
Module 2,5	= 45 mm
Module 3	= 50 mm
Module 4	= 60 mm
Module 5	= 75 mm
Module 6	= 75 mm

## Côte B

Module 1	= 15 mm
Module 1,5	= 17 mm
Module 2	= 20 mm
Module 2,5	= 25 mm
Module 3	= 30 mm
Module 4	= 40 mm
Module 5	= 50 mm
Module 6	= 50 mm

(1) (.....) : le module



# Engrenages à Denture Doite

REF	Z	Mod. 1				Mod. 1,5				Mod. 2				Mod. 2,5			
		De	Dp	dm	D1	De	Dp	dm	D1	De	Dp	dm	D1	De	Dp	dm	D1
EngMod../50	50	52	50	30	12	78,0	75,0	50	14	104	100	70	16	130,0	125,0	80	20
EngMod../51	51	53	51	40	12	79,5	76,5	60	14	106	102	70	16	132,5	127,5	80	20
EngMod../52	52	54	52	40	12	81,0	78,0	60	14	108	104	70	16	135,0	130,0	90	20
EngMod../53	53	55	53	40	12	82,5	79,5	60	14	110	106	70	16	137,5	132,5	90	20
EngMod../54	54	56	54	40	12	84,0	81,0	60	14	112	108	70	16	140,0	135,0	90	20
EngMod../55	55	57	55	40	12	85,5	82,5	60	14	114	110	70	16	142,5	137,5	90	20
EngMod../56	56	58	56	40	12	87,0	84,0	60	16	116	112	70	16	145,0	140,0	100	20
EngMod../57	57	59	57	40	12	88,5	85,5	60	16	118	114	70	16	147,5	142,5	100	20
EngMod../58	58	60	58	40	12	90,0	87,0	60	16	120	116	70	16	150,0	145,0	100	20
EngMod../59	59	61	59	40	12	91,5	88,5	60	16	122	118	70	16	152,5	147,5	100	20
EngMod../60	60	62	60	40	12	93,0	90,0	60	16	124	120	70	16	155,0	150,0	100	20
EngMod../61	61	63	61	50	12	94,5	91,5	70	16	126	122	80	16				
EngMod../62	62	64	62	50	12	96,0	93,0	70	16	128	124	80	16				
EngMod../63	63	65	63	50	12	97,5	94,5	70	16	130	126	80	16				
EngMod../64	64	66	64	50	12	99,0	96,0	70	16	132	128	80	16				
EngMod../65	65	67	65	50	12	100,5	97,5	70	16	134	130	80	16	167,5	162,5		20
EngMod../66	66	68	66	50	12	102,0	99,0	70	16	136	132	80	16				
EngMod../67	67	69	67	50	12	103,5	100,5	70	16	138	134	80	16				
EngMod../68	68	70	68	50	12	105,0	102,0	70	16	140	136	80	16				
EngMod../69	69	71	69	50	12	106,5	103,5	70	16	142	138	80	16				
EngMod../70	70	72	70	50	12	108,0	105,0	70	16	144	140	80	16	180,0	175,0		20
EngMod../72	72	74	72		12	111,0	108,0		16	148	144		16	185,0	180,0		20
EngMod../75	75	77	75		12	115,5	112,5		16	154	150		20	192,5	187,5		20
EngMod../76	76	78	76		12	117,0	114,0		16	156	152		20	195,0	190,0		20
EngMod../80	80	82	80		12	123,0	120,0		16	164	160		20	205,0	200,0		25
EngMod../85	85	87	85		12	130,5	127,5		16	174	170		20	217,5	212,5		25
EngMod../90	90	92	90		12	138,0	135,0		16	184	180		20	230,0	225,0		25
EngMod../95	95	97	95		12	145,5	142,5		16	194	190		20	242,5	237,5		25
EngMod../100	100	102	100		12	153,0	150,0		16	204	200		20	255,0	250,0		25
EngMod../110	110	112	110		12	168,0	165,0		16	224	220		20	280,0	275,0		25
EngMod../114	114	116	114		12	174,0	171,0		16	232	228		20	290,0	285,0		25
EngMod../120	120	122	120		12	183,0	180,0		16	244	240		20	305,0	300,0		25
EngMod../127	127	129	127		12	193,5	190,5		16	258	254		20	322,5	317,5		25

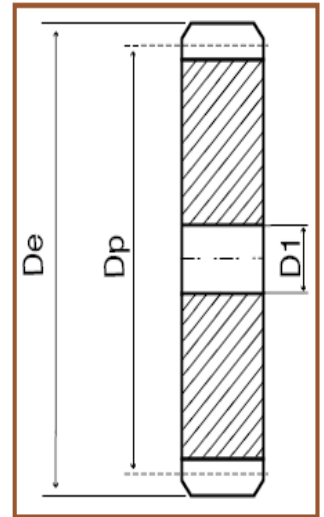
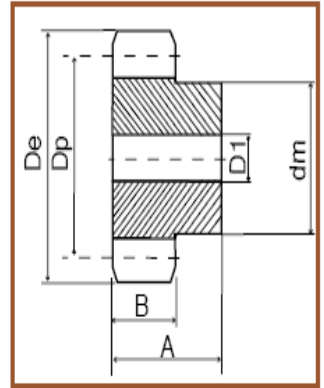

## Côte A

Module 1	= 25 mm
Module 1,5	= 30 mm
Module 2	= 35 mm
Module 2,5	= 45 mm
Module 3	= 50 mm
Module 4	= 60 mm
Module 5	= 75 mm
Module 6	= 75 mm

## Côte B

Module 1	= 15 mm
Module 1,5	= 17 mm
Module 2	= 20 mm
Module 2,5	= 25 mm
Module 3	= 30 mm
Module 4	= 40 mm
Module 5	= 50 mm
Module 6	= 50 mm

(1) (.....) : le module

# Engrenages à Denture Droite

REF	Z	Mod. 3				Mod. 4				Mod. 5				Mod.6			
		De	Dp	dm	D1	De	Dp	dm	D1	De	Dp	dm	D1	De	Dp	dm	D1
EngMod../12	12	42	36	27	12	56	48	35	14	70	60	45	20	84	72	54	20
EngMod../13	13	45	39	30	12	60	52	40	14	75	65	50	20	90	78	60	20
EngMod../14	14	48	42	33	12	64	56	45	14	80	70	55	20				
EngMod../15	15	51	45	35	12	68	60	45	14	85	75	60	20	102	90	70	20
EngMod../16	16	54	48	38	14	72	64	50	16	90	80	65	20	108	96	75	20
EngMod../17	17	57	51	42	14	76	68	50	16	95	85	70	20				
EngMod../18	18	60	54	45	14	80	72	50	16	100	90	70	20	120	108	80	20
EngMod../19	19	63	57	45	14	84	76	60	16	105	95	70	20				
EngMod../20	20	66	60	45	14	88	80	60	16	110	100	80	20	132	120	90	20
EngMod../21	21	69	63	45	16	92	84	70	16	115	105	80	20				
EngMod../22	22	72	66	50	16	96	88	70	16	120	110	80	20				
EngMod../23	23	75	69	50	16	100	92	75	20	125	115	90	20				
EngMod../24	24	78	72	50	16	104	96	75	20	130	120	90	20	156	144	110	25
EngMod../25	25	81	75	60	16	108	100	75	20	135	125	90	20	162	150	110	25
EngMod../26	26	84	78	60	16	112	104	75	20	140	130	100	20				
EngMod../27	27	87	81	60	16	116	108	75	20	145	135	100	20				
EngMod../28	28	90	84	60	16	120	112	75	20	150	140	100	25	180	168		25
EngMod../29	29	93	87	60	16	124	116	75	20	155	145	110	25				
EngMod../30	30	96	90	60	16	128	120	75	20	160	150	110	25	192	180		25
EngMod../31	31	99	93	60	16	132	124	80	20								
EngMod../32	32	102	96	70	16	136	128	80	20	170	160		25	204	192		25
EngMod../33	33	105	99	70	16	140	132	80	20								
EngMod../34	34	108	102	70	16	144	136	80	20								
EngMod../35	35	111	105	70	16	148	140	80	20	185	175		25	222	210		25
EngMod../36	36	114	108	70	20	152	144	80	25								
EngMod../37	37	117	111	70	20												
EngMod../38	38	120	114	80	20	160	152		25	200	190		25	240	220		25
EngMod../39	39	123	117	80	20												
EngMod../40	40	126	120	80	20	168	160		25	210	200		25	252	240		25
EngMod../41	41	129	123	80	20												
EngMod../42	42	132	126	80	20												
EngMod../43	43	135	129	80	20												
EngMod../44	44	138	132	90	20												
EngMod../45	45	141	135	90	20	188	180		25	235	225		25				
EngMod../46	46	144	138	90	20												
EngMod../47	47	147	141	100	20												
EngMod../48	48	150	144	100	20	200	192		25	250	240		25				
EngMod../50	50	156	150		20	208	200		25	260	250		30				
EngMod../52	52	162	156		20	216	208		25	270	260		30				
EngMod../55	55	171	165		20	228	220		25	285	275		30				
EngMod../57	57	177	171		20	236	228		25	295	285		30				
EngMod../60	60	186	180		20	248	240		25	310	300		30				
EngMod../65	65	201	195		20	268	260		25	335	325		30				
EngMod../70	70	216	210		25	288	280		25	360	350		30				
EngMod../72	72	222	216		25												
EngMod../75	75	231	225		25	308	300		25	385	375		30				
EngMod../76	76	234	228		25	312	304		30	390	380		30				
EngMod../80	80	246	240		25	328	320		30	410	400		30				
EngMod../85	85	261	255		25	348	340		30	435	425		30				
EngMod../90	90	276	270		25	368	360		30	460	450		30				
EngMod../95	95	291	285		25	388	380		30	485	475		30				
EngMod../100	100	306	300		25	408	400		30	510	500		30				
EngMod../110	110	336	330		25	448	440		30	560	550		30				
EngMod../114	114	348	342		30	464	456		30	580	570		30				
EngMod../120	120	366	360		30												
EngMod../127	127	387	381		30												

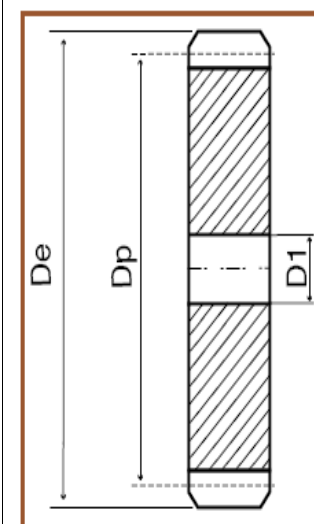
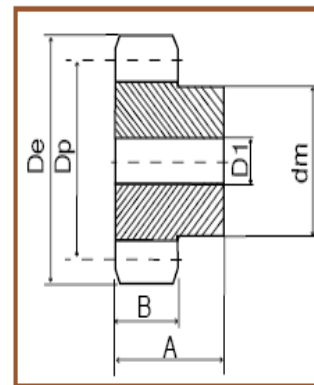

## Côte A

Module 1	= 25 mm
Module 1,5	= 30 mm
Module 2	= 35 mm
Module 2,5	= 45 mm
Module 3	= 50 mm
Module 4	= 60 mm
Module 5	= 75 mm
Module 6	= 75 mm

## Côte B

Module 1	= 15 mm
Module 1,5	= 17 mm
Module 2	= 20 mm
Module 2,5	= 25 mm
Module 3	= 30 mm
Module 4	= 40 mm
Module 5	= 50 mm
Module 6	= 50 mm

(1) (.....) : le module

# CREMAILLERES

Acier C43

M	Références	Section F x G	Références	Section F x G	Références	Section F x G
1	CAC 1 (Lg. 500)	15 x 15	CAC 1 (Lg. 1000)	15 x 15	CAC 1 (Lg. 2000)	15 x 15
1,5	CAC 1,5 (Lg. 500)	17 x 17	CAC 1,5 (Lg. 1000)	17 x 17	CAC 1,5 (Lg. 2000)	17 x 17
2	CAC 2 (Lg. 500)	20 x 20	CAC 2 (Lg. 1000)	20 x 20	CAC 2 (Lg. 2000)	20 x 20
2,5	CAC 2,5 (Lg. 500)	25 x 25	CAC 2,5 (Lg. 1000)	25 x 25	CAC 2,5 (Lg. 2000)	25 x 25
3	CAC 3 (Lg. 500)	30 x 30	CAC 3 (Lg. 1000)	30 x 30	CAC 3 (Lg. 2000)	30 x 30
4	CAC 4 (Lg. 500)	40 x 40	CAC 4 (Lg. 1000)	40 x 40	CAC 4 (Lg. 2000)	40 x 40
5	CAC 5 (Lg. 500)	50 x 50	CAC 5 (Lg. 1000)	50 x 50	CAC 5 (Lg. 2000)	50 x 50
6	CAC 6 (Lg. 500)	60 x 60	CAC 6 (Lg. 1000)	60 x 60	CAC 6 (Lg. 2000)	60 x 60

## Crémaillère Angle de Pression 20°

Section Carré

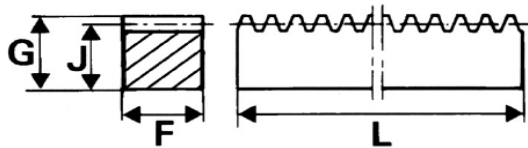

M	Références	Section F x G	Références	Section F x G	Références	Section F x G
1	CAM 1 (Lg. 480)	10 x 8				
1,5	CAM 1,5 (Lg. 480)	16 x 10				
2	CAM 2 (Lg. 452)	20 x 15	CAM 2 (Lg. 678)	20 x 15	CAM 2 (Lg. 1017)	20 x 15
2,5						
3	CAM 3 (Lg. 678)	30 x 20	CAM 3 (Lg. 1017)	30 x 20		
4	CAM 4 (Lg. 678)	40 x 25	CAM 4 (Lg. 1017)	40 x 25		
5	CAM 5 (Lg. 848)	50 x 30	CAM 5 (Lg. 1413)	50 x 30		
6	CAM 6 (Lg. 1017)	60 x 40				

Section Méplat

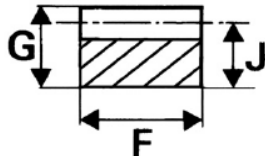

M	Références	Section F x G	Références	Section F x G	Références	Section F x G
1	CAH 1 (Lg. 480)	8 x 10				
1,5	CAH 1,5 (Lg. 480)	10 x 16				
2	CAH 2 (Lg. 452)	15 x 20	CAH 2 (Lg. 678)	15 x 20	CAH 2 (Lg. 1017)	15 x 20
2,5						
3	CAH 3 (Lg. 678)	20 x 30	CAH 3 (Lg. 1017)	20 x 30		
4	CAH 4 (Lg. 678)	25 x 40	CAH 4 (Lg. 1017)	25 x 40		
5	CAH 5 (Lg. 848)	30 x 50	CAH 5 (Lg. 1413)	30 x 50		
6	CAH 6 (Lg. 1017)	40 x 60				

Section Haute

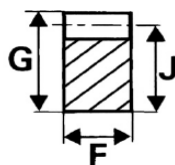

*PIGNONS ET ROUES  
A MOYEU AMOVIBLE*

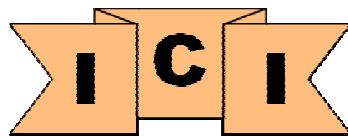

**06B**

Pignon à Moyeu Amovible  
pour chaîne Simple, Double et Triple  
Pas 9,525 x 5,72 mm

**ACIER C43**

Pignon Simple

Pignon Double

Pignon Triple

REF(1)	Z	De	Dp	Pignon Simple					Pignon Double					Pignon Triple					
				D	H	Moyeu	Fig (2)	M*	D	H	Moyeu	Fig (2)	M*	D	H	Moyeu	Fig (2)	M*	
PMA06B017	17	55,30	51,83	45	22	1008	1	0,10	41	22	1008	2	0,10						
PMA06B018	18	58,30	54,85	45	22	1008	1	0,10	41	22	1008	2	0,10						
PMA06B019	19	61,30	57,87	45	22	1008	1	0,20	46	22	1008	2	0,20	25,6	1008	5	0,20		
PMA06B020	20	64,30	60,89	45	22	1008	1	0,20	46	22	1008	2	0,20						
PMA06B021	21	68,00	63,91	45	22	1008	1	0,30	49	22	1008	2	0,30	25,6	1008	5	0,30		
PMA06B022	22	71,00	66,93	45	22	1008	1	0,30	59	25	1210	2	0,30						
PMA06B023	23	73,50	69,95	63	25	1210	1	0,30	59	25	1210	2	0,30	25,6	1210	5	0,40		
PMA06B024	24	77,00	72,97	63	25	1210	1	0,30	59	25	1210	2	0,30						
PMA06B025	25	80,00	76,02	63	25	1210	1	0,40	64	25	1210	2	0,40	25,6	1210	5	1,80		
PMA06B026	26	83,00	79,02	43	25	1210	1	0,40	64	25	1210	2	0,40						
PMA06B027	27	86,00	82,02	63	25	1210	1	0,50	70	25	1210	2	0,50	25,6	1210	5	0,50		
PMA06B028	28	89,00	85,07	63	25	1210	1	0,50	70	25	1210	2	0,50						
PMA06B030	30	94,70	91,12	63	25	1210	1	0,60	75	25	1210	2	0,60	79	38,0	1615	4	0,90	
PMA06B038	38	119,50	115,35	70	25	1210	1	1,00	80	25	1210	2	1,00	90	38,0	1615	4	1,80	
PMA06B045	45	140,70	136,55	70	25	1210	1	1,60	80	25	1210	2	1,60						
PMA06B057	57	176,90	172,91	70	25	1210	6	2,20	80	25	1210	7	2,90						
RMA06B076	76	234,90	230,49	70	25	1210	6	2,90	80	25	1210	7	4,00						
RMA06B095	95	292,50	288,08	80	25	1210	6	3,70	90	25	1210	7	6,20						
RMA06B114	114	349,50	345,68	80	25	1210	6	5,60	95	38	1210	7	8,00						

**08B**

Pignon à Moyeu Amovible  
pour chaîne Simple, Double et Triple  
Pas 12,7 x 7,75 mm

**ACIER C43**

Pignon Simple

Pignon Double

Pignon Triple

REF(1)	Z	De	Dp	Pignon Simple					Pignon Double					Pignon Triple					
				D	H	Moyeu	Fig (2)	M*	D	H	Moyeu	Fig (2)	M*	D	H	Moyeu	Fig (2)	M*	
PMA08B014	14	61,80	57,07	45	22	1008	1	0,20	46	22	1008	2	0,20						
PMA08B015	15	65,50	61,09	45	22	1008	1	0,20	46	22	1008	2	0,20	35	1008	5	0,3		
PMA08B016	16	69,50	65,10	45	22	1008	1	0,20	46	22	1008	2	0,20						
PMA08B017	17	73,60	69,11	60	25	1210	1	0,20	56	25	1210	2	0,20	35	1210	5	0,4		
PMA08B018	18	77,80	73,14	60	25	1210	1	0,30	56	25	1210	2	0,30		1210				
PMA08B019	19	81,70	77,16	63	25	1210	1	0,30	62	25	1210	2	0,40	35	1215	5	0,4		
PMA08B020	20	85,80	81,19	63	25	1210	1	0,30	62	25	1210	2	0,40						
PMA08B021	21	89,70	85,22	71	25	1610	1	0,40	70	25	1610	2	0,40	35	1615	5	0,6		
PMA08B022	22	93,80	89,24	71	25	1610	1	0,40	70	25	1610	2	0,50						
PMA08B023	23	98,20	93,27	76	25	1610	1	0,50	79	25	1610	2	0,60	35	1615	5	0,9		
PMA08B024	24	101,80	97,29	76	25	1610	1	0,50	79	32	1610	2	0,60						
PMA08B025	25	105,80	101,33	76	25	1610	1	0,60	87	32	2012	2	0,90	35	2012	5	0,9		
PMA08B026	26	110,00	105,36	76	25	1610	1	0,60	87	32	2012	2	0,90						
PMA08B027	27	114,00	109,40	76	25	1610	1	0,60	87	32	2012	2	0,90	35	2012	5	1,2		
PMA08B028	28	118,00	113,42	90	32	2012	1	0,70	87	32	2012	2	1,00						
PMA08B030	30	126,10	121,50	90	32	2012	1	0,90	87	32	2012	2	1,20	35	2012	5	1,9		
PMA08B032	32	134,30	129,56	90	32	2012	1	1,00	87	32	2012	2	1,60						
PMA08B035	35	146,70	141,68	90	32	2012	1	1,10											
PMA08B036	36	151,00	145,72	90	32	2012	1	1,20											
PMA08B038	38	158,60	153,80	90	32	2012	1	1,30	100	32	2012	2	2,50	35	2012	5	3,5		
PMA08B040	40	166,80	161,87	90	32	2012	1	1,50											
PMA08B045 (3)	45	188,60	182,07	100	32	2012	1	1,70	100	32	2012	2	3,70						
PMA08B057 (3)	57	237,10	230,54	100	32	2012	6	3,00	100	32	2012	7	6,00						
PMA08B076 (3)	76	313,19	307,33	100	32	2012	6	3,60	100	32	2012	7	10,60						
RMA08B095	95	390,10	384,11	100	32	2012	6	4,70	100	32	2012	7	6,50						
RMA08B114	114	466,90	460,90	110	45	2517	6	8,30	110	45	2517	7	10,30						

(1) : Préciser PMA06B/ PMA08B... + S : simple, D : double, T : triple + Code ~ (3) Roue Fonte ou Pignon

(2) Voir page 33

M\* : Masse

# 10B

Pignon à Moyeu Amovible  
pour chaîne Simple, Double et Triple  
Pas 15,875 x 9,65 mm



ACIER C43

REF(1)	Z	De	Dp	Pignon Simple					Pignon Double					Pignon Triple						
				D	H	Moyeu	Fig (2)	M*	D	H	Moyeu	Fig (2)	M*	D	H	Moyeu	Fig (2)	M*		
PMA10B012	12	68,00	61,34	46	22	1008	1	0,20			25,50	1008	3	0,30						
PMA10B013	13	73,00	66,32	47	22	1008	1	0,20			25,50	1008	3	0,30						
PMA10B014	14	78,00	71,34	52	22	1008	1	0,30			25,50	1008	3	0,40						
PMA10B015	15	83,00	76,36	60	25	1210	1	0,30			25,50	1210	3	0,40		42,1	1215	5	0,60	
PMA10B016	16	88,00	81,37	60	25	1210	1	0,30			25,50	1610	3	0,50						
PMA10B017	17	93,00	86,39	71	25	1610	1	0,40			25,50	1610	3	0,50		42,1	1615	5	1,00	
PMA10B018	18	98,30	91,42	71	25	1610	1	0,40			25,50	1610	3	0,60						
PMA10B019	19	103,30	96,45	75	25	1610	1	0,50			25,50	1610	3	0,70		42,1	1615	5	1,20	
PMA10B020	20	108,40	101,49	75	25	1610	1	0,60			25,50	1610	3	0,90						
PMA10B021	21	113,40	106,52	76	25	1610	1	0,70			25,50	1610	3	1,00		42,1	1615	5	1,70	
PMA10B022	22	118,00	111,55	76	25	1610	1	0,70			25,50	1610	3	1,20						
PMA10B023	23	123,40	116,58	76	25	1610	1	0,80	90	32	2012	2	1,30		42,1	1615	5	1,80		
PMA10B024	24	128,30	121,62	76	25	1610	1	1,00	90	32	2012	2	1,40							
PMA10B025	25	134,00	126,66	76	25	1610	1	1,00	90	32	2012	2	1,60	105	45	2517	4	1,80		
PMA10B026	26	139,00	131,70	90	32	2012	1	1,10	90	32	2012	2	1,80							
PMA10B027	27	144,00	136,75	90	32	2012	1	1,20	90	32	2012	2	2,00	120	45	2517	4	2,50		
PMA10B028	28	148,70	141,78	90	32	2012	1	1,30	90	32	2012	2	2,20							
PMA10B030	30	158,80	151,87	90	32	2012	1	1,40	90	32	2012	2	2,60	120	45	2517	4	3,50		
PMA10B032	32	168,90	161,95	90	32	2012	1	1,80	90	32	2012	2	3,20							
PMA10B038 (3)	38	199,20	192,24	111	32	2012	1	2,40	120	45	2012	2	4,70	120	45	2517	8	7,00		
PMA10B045 (3)	45	236,00	227,58	111	32	2012	6	2,80	120	45	2012	7	4,40							
PMA10B057 (3)	57	296,60	288,18	111	32	2012	6	4,40	120	45	2012	7	5,80							
RMA10B076	76	392,50	384,16	111	32	2012	6	5,10	120	45	2517	7	7,10							
RMA10B095	95	488,50	480,14	124	45	2517	6	8,60	120	45	2517	7	13,00							
RMA10B114	114	584,10	576,13	124	45	2517	6	15,50	120	45	2517	7	23,00							

# 12B

Pignon à Moyeu Amovible  
pour chaîne Simple, Double et Triple  
Pas 19,05 x 11,68 mm



ACIER C43

REF(1)	Z	De	Dp	Pignon Simple					Pignon Double					Pignon Triple						
				D	H	Moyeu	Fig (2)	M*	D	H	Moyeu	Fig (2)	M*	D	H	Moyeu	Fig (2)	M*		
PMA12B011	11	75,00	67,61	60	25	1008	1	0,30												
PMA12B012	12	81,50	73,60	60	25	1008	1	0,30												
PMA12B013	13	87,50	79,59	60	25	1210	1	0,30												
PMA12B014	14	93,60	85,61	70	25	1610	1	0,40												
PMA12B015	15	99,80	91,63	70	25	1610	1	0,40	71	38,5	1610	2	0,70		49,8	1615	5	1,10		
PMA12B016	16	105,50	97,65	76	25	1610	1	0,60	71	38,5	1610	2	0,90							
PMA12B017	17	111,50	103,67	76	25	1610	1	0,70	80	38,5	1610	2	1,20		49,8	1615	5	1,30		
PMA12B018	18	118,00	109,71	76	25	1610	1	0,80	80	38,5	1610	2	1,00							
PMA12B019	19	124,20	115,75	90	32	2012	1	1,00	90	32	2012	2	1,30		49,8	2012	5	2,00		
PMA12B020	20	129,70	121,78	90	32	2012	1	1,00	90	32	2012	2	1,40							
PMA12B021	21	136,00	127,82	102	45	2517	1	1,20	108	45	2012	2	1,60		49,8	2517	5	3,00		
PMA12B022	22	141,80	133,86	102	45	2517	1	1,40	108	45	2517	2	2,00							
PMA12B023	23	149,00	139,90	108	45	2517	1	1,70	108	45	1610	2	2,20		49,8	2517	5	3,80		
PMA12B024	24	153,90	145,94	108	45	2517	1	1,80	108	45	2517	2	2,60							
PMA12B025	25	160,00	152,00	108	45	2517	1	1,90	108	45	2517	2	2,90		49,8	2517	5	4,30		
PMA12B026	26	165,90	158,04	108	45	2517	1	2,10	108	45	2517	2	3,20							
PMA12B027	27	172,30	164,09	108	45	2517	1	2,20	108	45	2517	2	3,60	140	51	3020	4	4,80		
PMA12B028	28	178,00	170,13	108	45	2517	1	2,30	108	45	2517	2	3,90							
PMA12B030	30	190,50	182,25	108	45	2517	1	2,60	108	45	2517	2	4,70	140	51	3020	4	5,00		
PMA12B038 (3)	38	239,00	230,69	124	45	2517	1	4,50	140	51	3020	2	8,60	140	51	3020	4	12,50		
PMA12B045 (3)	45	283,20	273,10	124	45	2517	6	5,50	140	51	3020	7	7,70	140	51	3020	8	10,30		
PMA12B057 (3)	57	355,90	345,81	124	45	2517	6	6,20	140	51	3020	7	10,00	140	51	3020	8	14,00		
PMA12B076 (3)	76	469,90	460,99	124	45	2517	6	9,00	140	51	3020	7	14,50	140	51	3020	8	19,00		
RMA12B095	95	585,10	576,17	124	45	2517	6	13,00	140	51	3020	7	19,00	140	76	3020	8	27,00		
RMA12B114	114	700,60	691,36	124	63	2517	6	24,00	140	76	3030	7	31,00	140	76	3030	8	49,00		

(1) : Préciser PMA10B/PMA12B... + S : simple, D : double, T : triple + Code ~ (3) Roue Fonte ou Pignon

(2) Voir page 33 M\* : Masse

# 16B

Pignon à Moyeu Amovible  
pour chaîne Simple, Double et Triple  
Pas 25,4 x 17,2 mm



## ACIER C43

REF(1)	Z	De	Dp	Pignon Simple					Pignon Double					Pignon Triple					
				D	H	Moyeu	Fig (2)	M*	D	H	Moyeu	Fig (2)	M*	D	H	Moyeu	Fig (2)	M*	
PMA16B010	10	93,00	82,19	63	38	1215	1	0,80											
PMA16B011	11	99,50	90,14	63	38	1215	1	0,90											
PMA16B013	13	117,00	106,12	73	38	1615	1	1,00											
PMA16B014	14	125,00	114,15	73	38	1615	1	1,00											
PMA16B015	15	133,00	122,17	76	38	1615	1	1,20		47,7	2012	3	2,10						
PMA16B016	16	141,00	130,20	76	38	1615	1	1,40		47,7	2012	3	2,00						
PMA16B017	17	149,00	138,22	90	32	2012	1	1,40		47,7	2517	3	2,60		79,6	2517	5	4,00	
PMA16B018	18	157,00	146,28	90	32	2012	1	1,60		47,7	2517	3	3,10						
PMA16B019	19	165,20	154,33	108	45	2517	1	2,10		47,7	2517	3	3,70		79,6	3030	5	4,30	
PMA16B020	20	173,20	162,38	108	45	2517	1	2,30		47,7	2517	3	4,40						
PMA16B021	21	181,20	170,43	110	45	2517	1	2,50	140	51	3020	2	4,20		79,6	3030	5	6,50	
PMA16B022	22	189,30	178,48	110	45	2517	1	2,80	140	51	3020	2	4,90						
PMA16B023	23	197,50	186,53	110	45	2517	1	3,10	140	51	3020	2	5,80	159	89,0	3535	4	7,00	
PMA16B024	24	205,50	194,59	110	45	2517	1	3,40	140	51	3020	2	7,00						
PMA16B025	25	213,50	202,66	110	45	2517	1	3,60	140	51	3020	2	8,00	175	89	3535	4	11,30	
PMA16B026	26	221,60	210,72	110	45	2517	1	4,00	140	51	3020	2	9,00						
PMA16B027	27	229,60	218,79	110	45	2517	1	4,30	140	51	3020	2	9,50	175	89	3535	4	14,00	
PMA16B028	28	237,70	226,85	110	45	2517	1	4,60	140	51	3020	2	10,50						
PMA16B030	30	254,00	243,00	140	51	3020	1	4,90	140	76	3030	2	15,70	175	89	3535	4	18,00	
PMA16B032	32	270,00	259,13	120	45	2517	1	6,20											
PMA16B035	35	296,20	283,36	120	45	2517	1	10,00											
PMA16B038 (3)	38	320,70	307,59	140	51	3020	1	9,00	140	76	3030	2	21,00	175	89	3535 (4)	4	21,00	
PMA16B045 (3)	45	377,90	364,12	140	51	3020	6	10,00	140	76	3030	7	28,00	215	102	4040 (5)	8	28,00	
PMA16B057 (3)	57	474,90	461,07	140	51	3020	6	12,00	175	89	3535 (4)	7	37,00	215	102	4040 (5)	8	37,00	
PMA16B076 (3)	76	628,40	614,65	140	51	3020	6	21,00	175	89	3535 (4)	7	54,00	215	102	4030	8	54,00	
RMA16B095	95	781,10	768,22	140	51	3020	6	30,00	215	102	3525	7	78,00			4030	8	78,00	
RMA16B114	114	934,30	921,81	140	76	3030	6	45,00	215	102	4040	7	100,0			4545	8	100,0	

# 20B

Pignon à Moyeu Amovible  
pour chaîne Simple, Double et Triple  
Pas 31,75 x 19,56 mm



## ACIER C43

REF(1)	Z	De	Dp	Pignon Simple					Pignon Double					Pignon Triple					
				D	H	Moyeu	Fig (2)	M*	D	H	Moyeu	Fig (2)	M*	D	H	Moyeu	Fig (2)	M*	
PMA20B013	13	147,80	132,65	90	32	2012	1	1,50			2517	3	2,20						
PMA20B015	15	167,90	152,72	108	45	2517	1	2,40			2517	3	4,00			2517	5	13	
PMA20B017	17	187,90	172,78	108	45	2517	1	2,40			2517	3	5,00			3030	5	15	
PMA20B019	19	208,10	192,91	108	45	2517	1	2,70			3030	2	6,30			3030	5	17	
PMA20B021	21	228,20	213,04	108	45	2517	1	3,10			3030	2	8,80			3535	5	19	
PMA20B023	23	248,30	233,17	108	45	2517	1	3,50			3030	2	9,80			3535	5	23	
PMA20B025	25	268,50	253,33	108	45	2517	1	4,20			3030	2	10,50			3535	5	28	
PMA20B027	27	288,60	273,40	150	51	3020	1	4,30											
PMA20B030	30	318,90	303,75	150	51	3020	1	4,80			3030	2	14,00			3535	5	40	
RMA20B038	38	399,60	384,49	160	51	3020	6	13,50	140	76	3030	7	22,00	180	90	3535	8	35	
RMA20B045	45	470,30	455,17	160	51	3020	6	20,50	160	76	3030	7	28,00	180	90	3535	8	42	
RMA20B057	57	591,50	576,36	160	51	3020	6	25,50	160	90	3535	7	37,00	220	102	4040	8	62	
RMA20B076	76	783,50	768,32	160	51	3020	6	40,00	180	90	3535	7	62,00	260	114	4545	8		
RMA20B095	95	975,50	960,27	160	51	3030	6	55,00	180	90	3535	7	82,00	260	114	5050	8		
RMA20B114	114	1167,30	1152,26	160	51	3030	6	72,00	200	102	4040	7	105,00	260	114	5050	8		

(1) : Préciser PMA16B/PMA20B..... + S : simple, D : double, T : triple + Code

(2) Voir page 33 ~ (3) Roue Fonte ou Pignon

M\* : Masse ~ (4) : Roue Fonte : 3525, Pignon : 3535 ~ (5) : Roue Fonte : 4030, Pignon : 4040



## ACIER C43

### Pignon Simple

### Pignon Double

### Pignon Triple

REF(1)	Z	De	Dp	Pignon Simple					Pignon Double					Pignon Triple						
				D	H	Moyeu	Fig (2)	M*	D	H	Moyeu	Fig (2)	M*	D	H	Moyeu	Fig (2)	M*		
PMA24B009	9	126,40	111,40	70	39	1615	1	1,20												
PMA24B010	10	138,00	123,29	80	39	1615	1	1,60												
PMA24B011	11	150,00	135,21	90	32	2012	1	1,70												
PMA24B012	12	162,00	147,22	90	32	2012	1	2,20												
PMA24B013	13	174,20	159,18	114	45	2517	1	2,80		72	2517	3	5,30							
PMA24B014	14	186,20	171,22	128	45	2517	1	3,60												
PMA24B015	15	198,20	183,26	128	51	2517	1	4,40		72	3020	3	6,60			3020	5	20		
PMA24B016	16	210,30	195,30	140	51	3020	1	4,60												
PMA24B017	17	222,30	207,34	140	51	3020	1	5,40		72	3020	3	10,30			3030	5	25		
PMA24B018	18	234,30	219,42	140	51	3020	1	6,10												
PMA24B019	19	246,50	231,49	140	51	3020	1	6,60	140	76	3030	2	14,80			3535	5	30		
PMA24B020	20	258,60	243,57	140	51	3020	1	7,50												
PMA24B021	21	270,60	255,65	140	51	3020	1	8,40	140	76	3030	2	19,50			4040	5	35		
PMA24B023	23	294,80	279,80	160	51	3020	1	11,30	140	76	3535	2	24,00			4545	5	44		
PMA24B025	25	319,00	304,00	160	51	3020	1	13,20	140	76	3535	2	29,00			4545	8	50		
PMA24B030	30	379,50	364,50	160	51	3020	1	21,00	140	76	3535	2	40,00			4545	8	60		
RMA24B038	38	476,20	461,39	160	76	3030	6	24,00	180	90	3535	7	44,00			4545	8	66		
RMA24B045	45	561,20	546,20	160	76	3030	6	30,00	180	90	3535	7	55,00			4545	8	80		
RMA24B057	57	706,50	691,63	160	76	3030	6	45,00	180	90	3535	7	72,00			4545	8	120		
RMA24B076	76	936,9	921,98	180	90	3535	6	70,00	220	102	4040	7	107,00			4545	8			
RMA24B095	95	1166,7	1152,33	180	90	3535	6		220	102	4040	7			4545	8				
RMA24B114	114	1397,70	1382,72	220	102	4040	6		260	114	4545	7			4545	8				

(1) : Préciser PMA24B... + S : simple, D : double, T : triple + Code

(2) Voir page 33 ~ (3) Roue Fonte ou Pignon

M\* : Masse ~ (4) : Roue Fonte : 3525, Pignon : 3535 ~ (5) : Roue Fonte : 4030, Pignon : 4040



# FIGURES

1

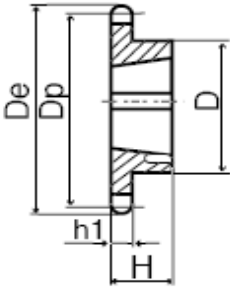

2

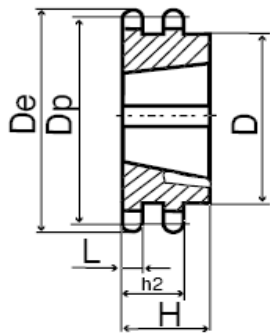

2

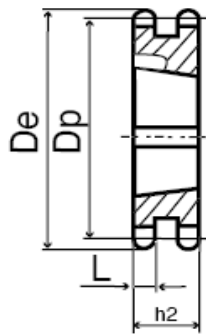

4

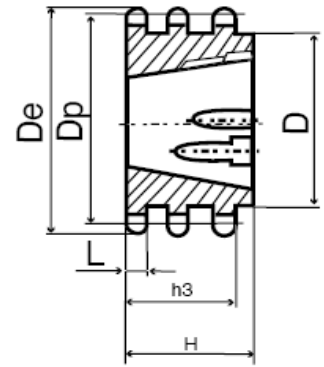

5

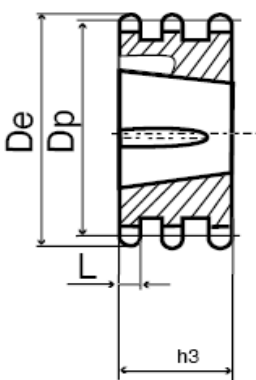

6

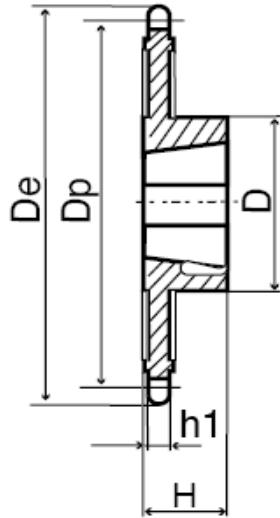

7

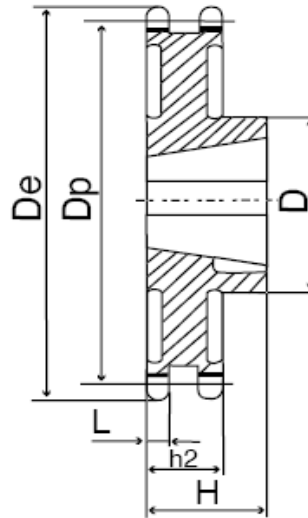

8

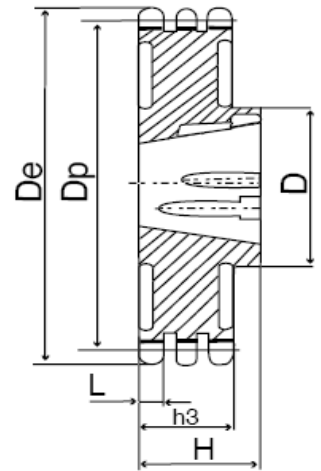

# *MOYEU AMOVIBLE*



**I C I**

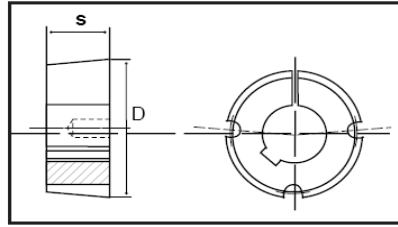

### Alésages Standard Métriques

REF	Alésage en mm																	S	Masse	D	C	
1008	9	10	11	12	14	15	16	18	19	20	22	24						22,30	0,12	35,00	5,7	
1108	9	10	11	12	14	15	16	18	19	20	22	24	25					22,30	0,16	38,00	5,7	
1210	11	12	14	15	16	18	19	20	22	24	25	28	25	28				25,40	0,28	47,50	20	
1215	11	12	14	15	16	18	19	20	22	24	25	28	30	32				38,10	0,39	47,50	20	
1310	12	14	15	16	18	19	20	22	24	25	28	30	30	32				25,40	0,32	50,50	20	
1610	12	14	15	16	18	19	20	22	24	25	28	30	32		38	40	42	25,40	0,42	57,00	20	
1615	12	14	15	16	18	19	20	22	24	25	28	30	32	35	38	42		38,10	0,61	57,00	20	
2012	14	15	16	18	19	20	22	24	25	28	30	32	32	35	40	45	48	50	31,80	0,75	70,00	31
2517	19	20	22	24	25	28	30	32	35	38	40	42	35	35	50	42	60	65	44,50	1,10	85,50	49
3020	25	28	30	32	35	38	40	42	45	48	50	55	45	38	70	55		50,80	2,61	108,00	92	
3030	25	28	30	32	35	38	40	42	45	48	50	55	60	48	70	75		76,20	3,80	108,00	92	
3525	28	30	32	35	38	40	42	45	48	50	55	60	60	65	75	75	85	90	63,50	3,9	127,00	115
3535	28	30	32	35	38	40	42	45	48	50	55	60	65	65	75	80	85	90	88,90	5,25	127,00	115
4040	40	42	45	48	50	55	60	65	70	75	80	85	65	70	100	80		101,60	7,80	146,00	172	
4535	55	60	65	70	75	80	85	90	95	100	105	110	90	70								
4545	55	60	65	70	75	80	85	90	95	100	105	110		95				114,30	12,80	162,00	195	
5040	70	75	80	85	90	95	100	105	110	115	120	125										
5050	70	75	80	85	90	95	100	105	110	115	120	125						127,00	15,30	177,5	275	

C : Couple de Serrage (Nm)

D	b	t
De 10 à 12	4	D + 1,8
De 12 à 17	5	D + 2,3
De 17 à 22	6	D + 2,8
De 22 à 30	8	D + 3,3
De 30 à 38	10	D + 3,3
De 38 à 44	12	D + 3,3
De 44 à 50	14	D + 3,8
De 50 à 58	16	D + 4,3
De 58 à 65	18	D + 4,4
De 65 à 75	20	D + 4,9
De 75 à 85	22	D + 5,4
De 85 à 95	25	D + 5,4
De 95 à 110	28	D + 6,4
De 110 à 130	32	D + 7,4

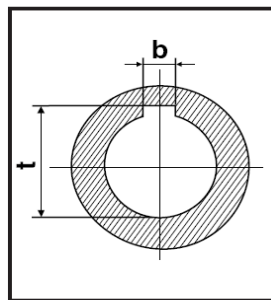

D	Dimensions des Rainures de Clavette	
	b	t
28	8	D + 1,3
35	10	D + 1,3
40/42	12	D + 1,3
50	14	D + 2,8
90	25	D + 3,4
100	28	D + 5,4

### Alésage en Pouces

REF	Alésage en Pouces																	S	Masse	D	
1008	3/8	1/2	5/8	3/4	7/8	15/16												22,20	0,12	35,00	
1108	1/2	9/16	5/8	11/16	3/4	7/8	1	11/8										22,20	0,15	38,00	
1210	1/2	5/8	11/16	7/8	15/16	1	11/4											25,40	0,30	47,50	
1215	1/2	5/8	15/16															38,10	0,40	47,50	
1610	1/2	5/8	3/4	7/8	15/16	11/18	11/4	13/8	11/2	15/8								25,40	0,50	57,00	
2012	1/2	5/8	11/16	3/4	7/8	1	11/8	11/4	13/8	11/2	15/8	13/4	17/8	2	21/8			31,75	0,80	70,00	
2017	1	11/4	11/2	13/4	17/8																
2517	3/4	7/8	1	11/8	11/4	11/2	15/8	13/4	17/8	2	21/8	21/4	23/8	21/2	42			44,45	1,60	85,50	
3020	15/16	1	11/8	11/4	13/8	15/8	13/4	17/8	2	21/8	21/4	23/8	21/2	25/8	23/4	27/8	3	50,80	3,00	108,00	

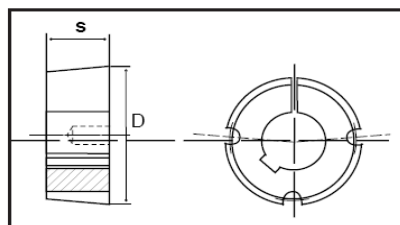



S.A.S au capital de 1600 Euros - Registre du commerce: 528 597 503 - R.C.S Nanterre  
A.P.E: 4669B - TVA Intracommunautaire: FR49528597503  
Siège Social: 33, 39 Avenue Henri Barbusse - 92700 Colombes - Fax: ( 33 ) 179 723 539

Magasins & Services commerciaux:

165 route de Bezons Z.I. Les Amandiers 78420 Carrières  
Tél: ( 33 ) 130 860 300 - Fax: ( 33 ) 130 860 123 - Email: [ici.composants@free.fr](mailto:ici.composants@free.fr) - Web: [www.ici-composants.com](http://www.ici-composants.com)